

XT-17M-C1 relay - Multifunctional time, 16 A, 1 C/O

Datasheet



Description

The XT-17M-C1 is a multifunctional time relay and fullfills all requirements for any function. To be controlled by a supply voltage or control input.

Choice of 10 time ranges:

0.1 - 1 s	1 - 10 s	0.1 - 1 min	1 - 10 min
0.1 - 1 h	1 - 10 h	0.1 - 1 d	1 - 10 d
Only on	Only off		

The relay has an universal supply voltage 12 - 240 V AC/DC and 1 change-over contact 16 A /AC1. It has a multifunctional red LED output indicator that flashes or shines depending of the status.

Application

Multifunctional time relay, suitable for general purpose applications. For example to be used for electrical appliances, control of lights, heating, motors, pumps and fans.

Features

- 10 functions
 - Delay-on after energisation
 - Delay-off after energisation
 - Recycler starting off
 - Recycler starting on
 - Delay-off after break of S contact
 - Delay-off after make of S contact
 - Delay-off after make and break of S contact
 - Delay-on / off
 - Latching
 - Pulse generator
- 1 C/O contact 16 A / AC1
- 35 mm rail mounting
- LED indicator red and green
- Universal supply voltage 12...240 VAC/DC
- Time range 0.1 s - 10 d
- Modular housing, 1 module

Benefits

- Rated current 16 A / AC1
- Long term availability
- 17.6 mm wide
- No maintenance

Industry compliancy

All our relays and accessories are designed according to regulations:

- EN 60255-6
- EN 61010-1
- CE

XT-17M-C1 relay

Technical specifications

Connection diagram

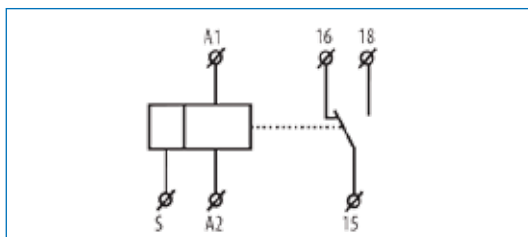

Time range

Time range	0.1 s - 10 d / only-on / only-off
Time setting	Rotary switch & potentiometer
Time deviation	5% mechanical setting
Repeat accuracy	0.2% set value stability
Temp. coefficient	0.01% / °C, at 20 °C

Control

Load between S-A2	Yes
Control terminals	A1-S
Max. capacity of cable control	0.1 μF
	without connected glow-lamps
	without connected glow-lamps
	Glow-lamps cannot connected / N/O
	9 nF (AC 230 V), max. 20 pcs (1 pc - 1 mA)
Impulse length	Min. 25 ms / Max. unlimited
Reset time	Max. 150 ms

Output

Number of contacts	1 change-over / SPDT (AgNi/silver alloy)
Rated current	16 A / AC1
Breaking capacity	4000 VA / AC1, 384 W / DC
Inrush current	30 A / < 3 s
Switching voltage	250 V AC1 / 24 VDC
Min. breaking capacity DC	500 mW
Output indication	red LED
Mechanical life	3 x 10 ⁷ operations
Electrical life (AC1)	7 x 10 ⁴ operations

XT-17M-C1 relay

Technical specifications

Supply

Supply terminals	A1 - A2
Supply voltage (μ n)	12 - 240 VAC/DC 50/60 Hz
Supply indication	Green LED
Power consumption	AC 0.7 - 3 VA / DC 0.5 - 1.7 W
Supply voltage tolerance	0.85...1.1 U _n

Connection

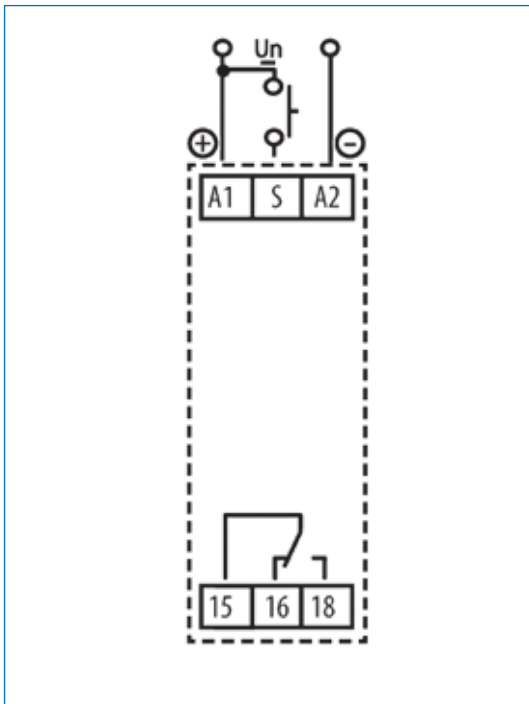

XT-17M-C1 relay

Technical specifications

Environmental conditions

Operating temperature	-20 °C...+55 °C
Storage temperature	-30 °C...+70 °C
Electrical strength	4 kV (supply output)
Operating position	Any
Mounting	35 mm rail EN 60715
Protection degree	IP40 front panel / IP20 terminals
Overvoltage category	III
Pollution degree	2
Max. cable size	Solid wire max. 1 x 2.5 or 2 x 1.5 mm ² / with sleeve max. 1 x 2.5 mm ²

Mechanical data

Dimensions (d x w x h)	90 x 17.6 x 64 mm
Weight	64 g
Standards	EN 61812-1, EN 61010-1



XT-17M-C1 relay

Technical specifications

Description

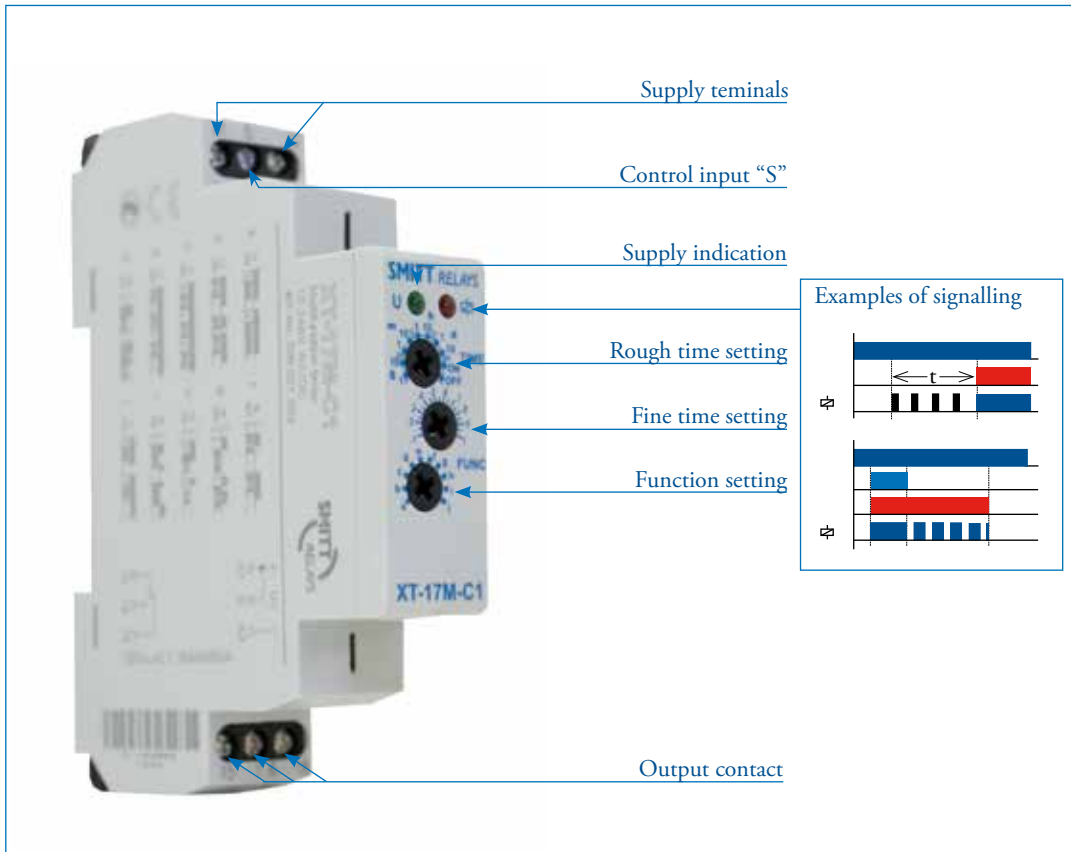

Time ranges

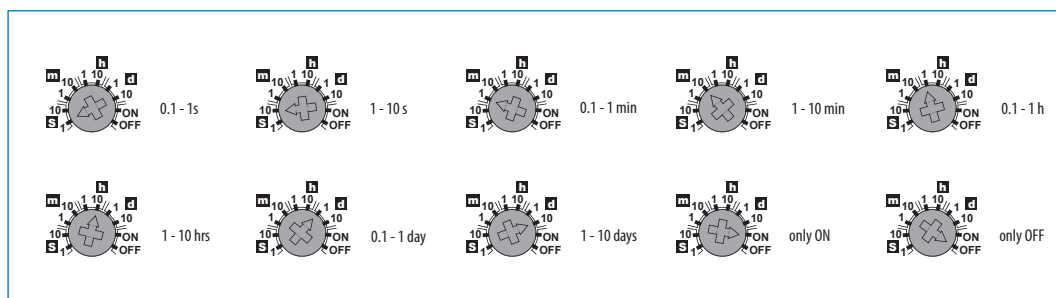

XT-17M-C1 relay

Technical specifications

Functions

Delay-on after energisation

When input voltage U is applied, timing delay t begins. Relay contacts R change state after time delay is complete. Contacts R return to their shelf state when input voltage U is removed. Trigger switch is not used in this function.



Delay-off after energisation

When input voltage U is applied, relay contacts R change state immediately and timing cycle begins. When time delay is complete, contacts return to shelf state. When input voltage U is removed, contacts will also return to their shelf state. Trigger switch is not used in this function.



Recycler starting off

When input voltage U is applied, time delay t begins. When time delay t is complete, relay contacts R change state for time delay t . This cycle will repeat until input voltage U is removed. Trigger switch is not used in this function.



Recycler starting on

When input voltage U is applied, relay contacts R change state immediately and time delay T begins. When time delay t is complete, contacts return to their shelf state for time delay t . This cycle will repeat until input voltage U is removed. Trigger switch is not used in this function.

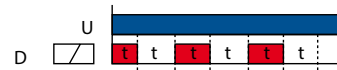

Delay-off after break of S contact

Input voltage U must be applied continuously. When trigger switch S is closed, relay contacts R change state. When trigger switch S is opened, delay t begins. When delay t is complete, contacts R return to their shelf state. If trigger switch S is closed before time delay t is complete, then time is reset.



When trigger switch S is opened, the delay begins again, and relay contacts R remain in their energized state. If input voltage U is removed, relay contacts R return to their shelf state.

Delay-off after make of S contact

Upon application of input voltage U , the relay is ready to accept trigger signal S . Upon application of the trigger signal S , the relay contacts R transfer and the preset time t begins. During time-out, the trigger signal S is ignored. The relay resets by applying the trigger switch S when relay is not energized.

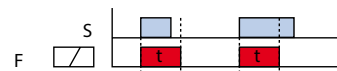

Delay-off after make and break of S contact

Upon application of input voltage U , the relay is ready to accept trigger signal S . Upon application of the trigger signal S , the relay contacts R transfer and the preset time t begins. At the end of the preset time t , the relay contacts R return to preset time out t (before preset time elapses). Continuously cycling of the trigger switch S at a rate faster than the preset time will cause the relay contacts R to remain closed. If input voltage U is removed, relay contacts R return to their shelf state.

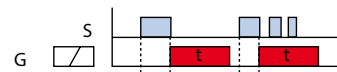

Delay-on and -off

Input voltage U must be applied continuously. When trigger switch S is closed, time delay T begins. When time delay T is complete, relay contacts R change state and remain transferred until trigger switch S is opened. If input voltage U is removed, relay contacts R return to their shelf state.

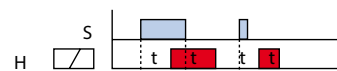

Latching

Input voltage U must be applied continuously. Output changes state with every trigger switch S closure. If input voltage U is removed, relay contacts R return to their shelf state.



Pulse generator

Upon application of input voltage U , a single output pulse of 0.5 seconds is delivered to relay after time delay t . Power must be removed and reapplied to repeat pulse. Trigger switch is not used in this function.



XT-17M-C1 relay

Ordering codes

Art. no.	Type	Time range	Function	Contacts	Voltage range
326001001	XT-17M-A1	0.1 - 1 s	Delay-on	1 C/O	12 - 240 VAC/DC, 50/60 Hz
326001009	XT-17M-A2	1 - 10 s	Delay-on	1 C/O	12 - 240 VAC/DC, 50/60 Hz
326001010	XT-17M-A3	6 - 60 s	Delay-on	1 C/O	12 - 240 VAC/DC, 50/60 Hz
326001011	XT-17M-A4	1 - 10 min	Delay-on	1 C/O	12 - 240 VAC/DC, 50/60 Hz
326001012	XT-17M-A5	6 - 60 min	Delay-on	1 C/O	12 - 240 VAC/DC, 50/60 Hz
326001013	XT-17M-A6	1 - 10 h	Delay-on	1 C/O	12 - 240 VAC/DC, 50/60 Hz
326001002	XT-17M-B1	0.1 - 1 s	Delay-off	1 C/O	12 - 240 VAC/DC, 50/60 Hz
326001014	XT-17M-B2	1 - 10 s	Delay-off	1 C/O	12 - 240 VAC/DC, 50/60 Hz
326001015	XT-17M-B3	6 - 60 s	Delay-off	1 C/O	12 - 240 VAC/DC, 50/60 Hz
326001016	XT-17M-B4	1 - 10 min	Delay-off	1 C/O	12 - 240 VAC/DC, 50/60 Hz
326001017	XT-17M-B5	6 - 60 min	Delay-off	1 C/O	12 - 240 VAC/DC, 50/60 Hz
326001018	XT-17M-B6	1 - 10 h	Delay-off	1 C/O	12 - 240 VAC/DC, 50/60 Hz
326001003	XT-17M-C1	0.1 s - 10 d	Multifunction	1 C/O	12 - 240 VAC/DC, 50/60 Hz
326001004	XT-17M-C3	0.1 s - 10 d	Multifunction	3 C/O	12 - 240 VAC/DC, 50/60 Hz
326001025	XT-17M-C1/6	0.1 s - 10 h	Multifunction	1 C/O	24 - 240 VAC, 50/60 Hz or 24 VDC
326001019	XT-17M-D	0.1 s - 10 min	Delay-on / Delay-off*	2 C/O	12 - 240 VAC/DC, 50/60 Hz
326001020	XT-17M-L	-	Latching	2 C/O	12 - 240 VAC/DC, 50/60 Hz
326001005	XT-17M-P	0.1 s - 100 d	Recycler	1 C/O	12 - 240 VAC/DC, 50/60 Hz
326001006	XT-17M-S	0.1 s - 100 d	Star-delta	2 C/O	12 - 240 VAC/DC, 50/60 Hz
326001021	XT-17M-2XA	0.1 s - 10 d	Delay-on	2x 1 C/O	12 - 240 VAC/DC, 50/60 Hz
326001026	XT-35M-DC2	Weekly	Digital time	2 C/O	12 - 240 VAC/DC, 50/60 Hz
326001028	XT-35M-DCL1	Daily - weekly	Digital twilight switch	1 C/O	230 VAC, 50/60 Hz

* without auxiliary supply





www.morssmitt.com



Mors Smitt France SAS

Tour Rosny 2, Avenue du Général de Gaulle,
F - 93118 Rosny-sous-Bois Cedex, FRANCE
T +33 (0)1 4812 1440, F +33 (0)1 4855 9001
E sales@msrelais.com

Mors Smitt Asia Ltd.

807, Billion Trade Centre, 31 Hung To Road
Kwun Tong, Kowloon, HONG KONG SAR
T +852 2343 5555, F +852 2343 6555
E info@morssmitt.hk

Mors Smitt B.V.

Vrieslantlaan 6, 3526 AA Utrecht,
NETHERLANDS
T +31 (0)30 288 1311, F +31 (0)30 289 8816
E sales.msbv@wabtec.com

Mors Smitt Technologies Inc.

1010 Johnson Drive,
Buffalo Grove, IL 60089-6918, USA
T +1 847 777 6497, F +1 847 520 2222
E salesmst@wabtec.com

Mors Smitt UK Ltd.

Doulton Road, Cradley Heath
West Midlands, B64 5QB, UK
T +44 (0)1384 567 755, F +44 (0)1384 567 710
E sales.msuk@wabtec.com