

/// Plug-in general purpose relay

M-relay

General purpose relay, 2, 3 or 4 pole, 7-12 A



Description

M2, M3 and M4 are miniature industrial relays for general purpose applications.

Rated contact switching current up to 12 A, depending on relay type.

Standard equipped with mechanical indicator and lockable front test button and optionally with LED indicator and surge suppression diode.

Accessories include also retainer clips and connection strips.

Application

Our general purpose relays are applied mainly in industrial and power automation systems, in signaling and protection systems and in other control and electric drives systems.

Features

- Miniature plug-in design
- 2, 3 or 4 C/O contacts
- AC and DC coils
- Standard mechanical indicator
- Standard lockable front test button
- Flat and silver relay pins for excellent connection in socket
- Universal pinning
- Transparent cover
- LED optional
- Surge suppression diode optional
- Test buttons (non latching) optional
- Cadmium free contacts
- Flash barriers
- Wide range of sockets
- Mounting sockets for 35 mm rail (EN 50022)
- Rail sockets equipped with screw terminals or spring terminals

Connection diagram

M2

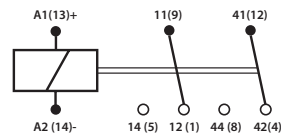

M3

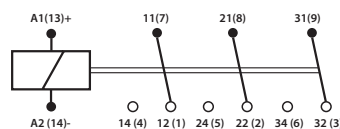

M4

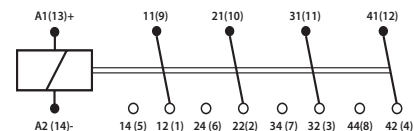

Approvals

EN 60255
 EN 60947
 EN 60947-5-1
 IEC 61810-1



General purpose relay

M-relay

Manual test / latching button

The test button can be used in two ways:

1. The plastic tab is broken off. In this situation, when the test button is pushed, the contacts operate, when the test button is released the contacts return to their previous state.
2. The plastic tab remains in tact. In this situation, when the test button is pushed and rotated, the contacts are latched in the operating state, and remain so until the test button is rotated back to its former position.

Coil characteristics DC-versions

Operating time at nominal voltage	
Pull-in time	13 ms
Release time	3 ms
Operating voltage range in %	0.75 - 1.1 Unom
Nominal power consumption	0.9 W
Min hold-up voltage	0.1 Unom

Type	Rated voltage Un VDC	Coil resistance at 20 °C Ω	Coil operating range VDC	
			min. (at 20°C)	max. (at 55°C)
D 012	12	110	9.6	13.2
D 024	24	640	19.2	26.4
D 048	48	2600	38.4	52.8
D 110	110	13600	88	121
D125	125	16000	100	137.5
D 220	220	54000	176	242

Other voltages on request

Coil characteristics AC-versions

Operating time at nominal voltage	
Pull-in time	10 ms
Release time	8 ms
Operating voltage range in %	0.75 - 1.1 Unom
Nominal power consumption	1.6 VA
Min hold-up voltage	0.2 Unom

Type	Rated voltage Un VAC	Coil resistance at 20 °C Ω	Coil operating range VAC	
			min. (at 20°C)	max. (at 55°C)
A 012	12	39.6	9.6	13.2
A 024	24	158	19.2	26.4
A 048	48	640	38.4	52.8
A 110	110	3450	88	121
A 230	230	16100	184	253

Other voltages on request

General purpose relay

M-relay

Contact characteristics

	M2	M3	M4
Maximum inrush current	24 A	20 A	12 A
Maximum continuous current	12 A	10 A	7 A
Maximum switching voltage	250 VDC, 400 VAC		
Minimum switching voltage/current AgNi	10 V / 5 mA		
Material	AgNi*		
Contact resistance	≤100 mΩ		

* AgNi/Au 0.2 μm on request

Performance characteristics

Electrical life (AC1)	≥ 10 ⁵
Mechanical life	≥ 2 x 10 ⁶ cycles (Unpowered)
Dielectric strength	Between coil contacts 2500 VAC Contact clearance 1000 VAC Pole-pole M2&M3: 2500 VAC, M4: 2000 VAC
Isolation class	C400
Max. operating frequency	At rated load 1200 cycles/hour (AC1) No load M2: 12000 cycles/hour, M3&M4: 18000 cycles/hour

Mechanical characteristics

Dimensions (d x w x h)	37.5 x 21.2 x 35.6 mm
Weight	35 g

Environmental characteristics

Storage temperature	-40 °C...+85 °C
Operating temperature	AC -40 °C...+55 °C DC -40 °C...+70 °C
Shock & vibrations	Shocks: NO: 10 g, NC: 5 g Vibrations: 5 g, 10-150 Hz
Environment protection	EN 116000-3: RTI
Degree of protection	EN 60529: IP 40

Compliance

EN 60255	Relay design and environmental conditions
EN 60947	Low voltage switch gear and control gear
EN 60947-5-1	Electromechanical control circuit devices and switching elements
IEC 61810-1	Electromechanical elementary relays
The relays meet the requirements of the RoHS directive	

General purpose relay
M-relay

Dimensions (mm)

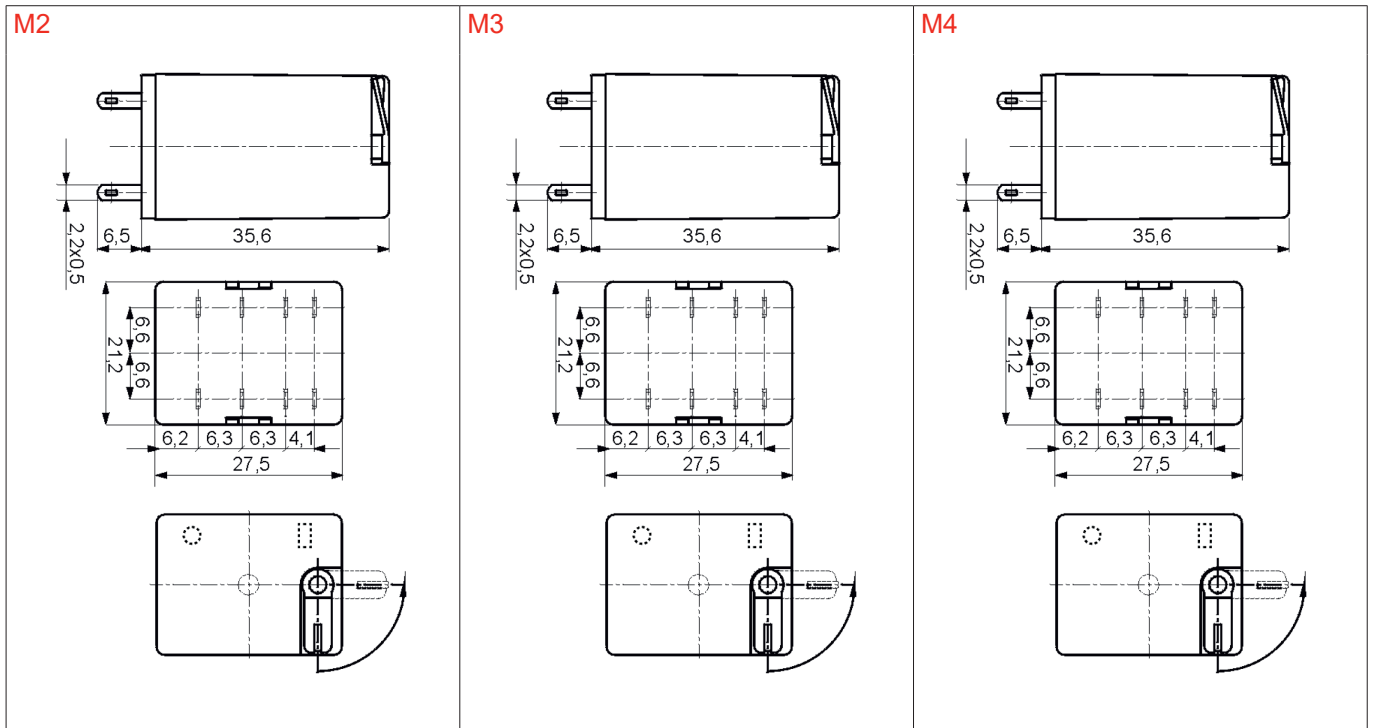

Options

Code	Description
L	LED

* Standard coil is 50 Hz, 60 Hz coil on request

General purpose relay M-relay

Electrical life expectancy M2

The life expectancy values shown below are based on factory tests. These values could be different in real life applications as environmental conditions, switching frequencies and duty cycles will influence these values.

Electrical life at AC resistive load. Fig. 1
Switching frequency: 1 200 cycles/hour

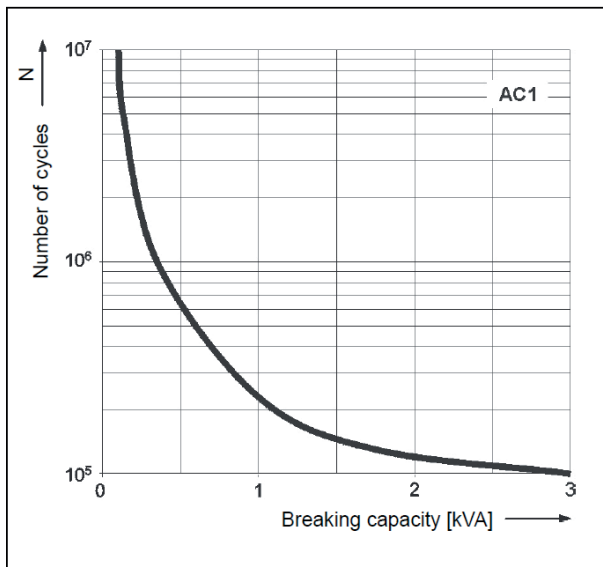

Electrical life reduction factor at AC inductive load Fig. 2

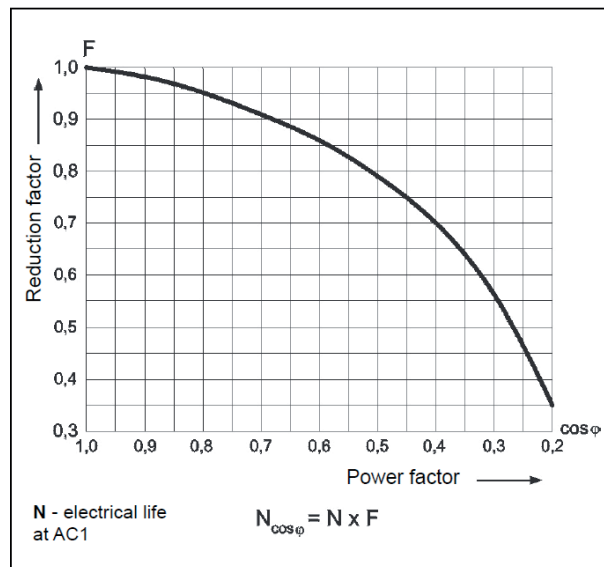

Max. DC resistive load breaking capacity Fig. 3

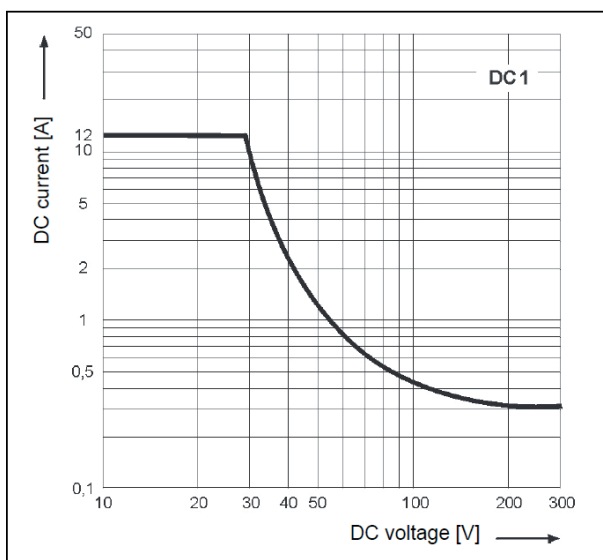

General purpose relay M-relay

Electrical life expectancy M3

The life expectancy values shown below are based on factory tests. These values could be different in real life applications as environmental conditions, switching frequencies and duty cycles will influence these values.

Electrical life at AC resistive load.
Switching frequency: 1 200 cycles/hour

Fig. 1

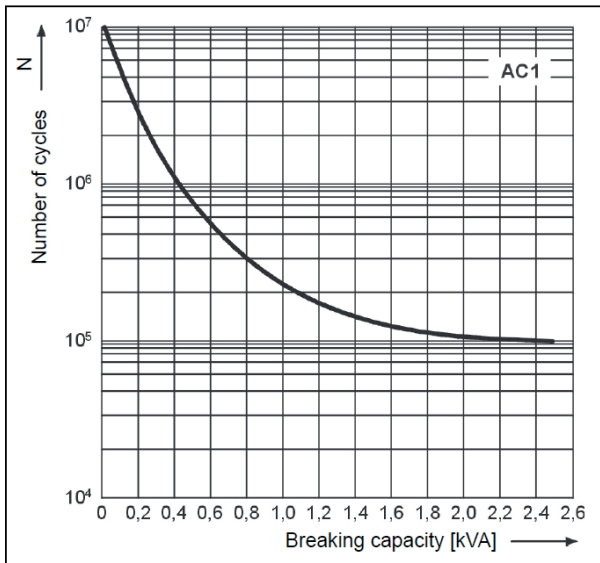

Electrical life reduction factor at AC inductive load

Fig. 2

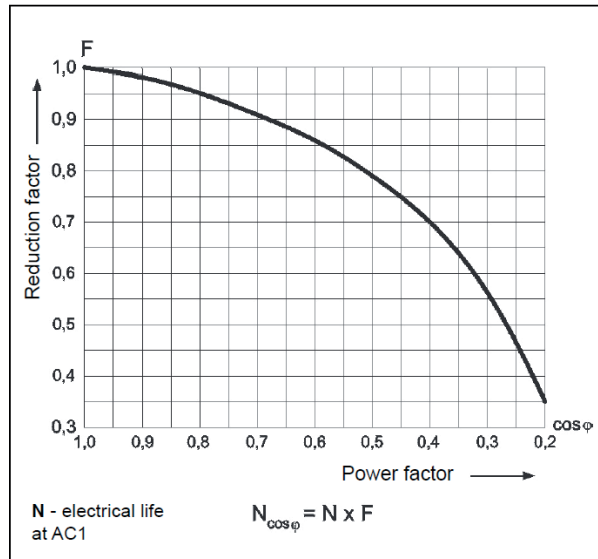

Max. DC breaking capacity
A - resistive load DC1
B - inductive load L/R = 40 ms

Fig. 3

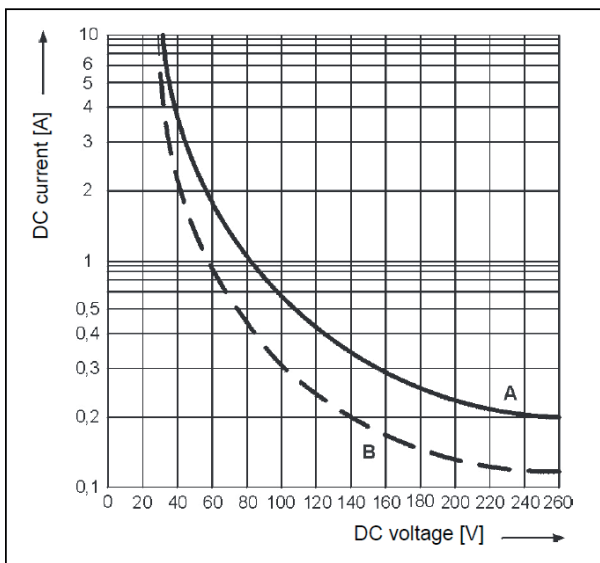

General purpose relay M-relay

Electrical life expectancy M4

The life expectancy values shown below are based on factory tests. These values could be different in real life applications as environmental conditions, switching frequencies and duty cycles will influence these values.

Electrical life at AC resistive load. Fig. 1
 Switching frequency: 1 200 cycles/hour

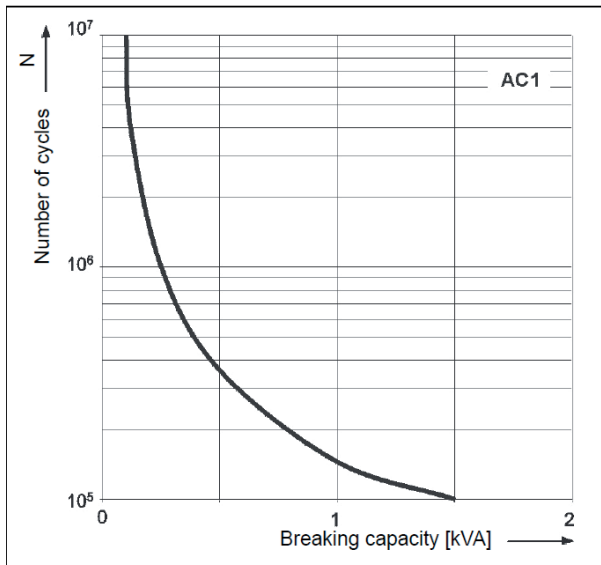

Electrical life reduction factor at AC inductive load Fig. 2

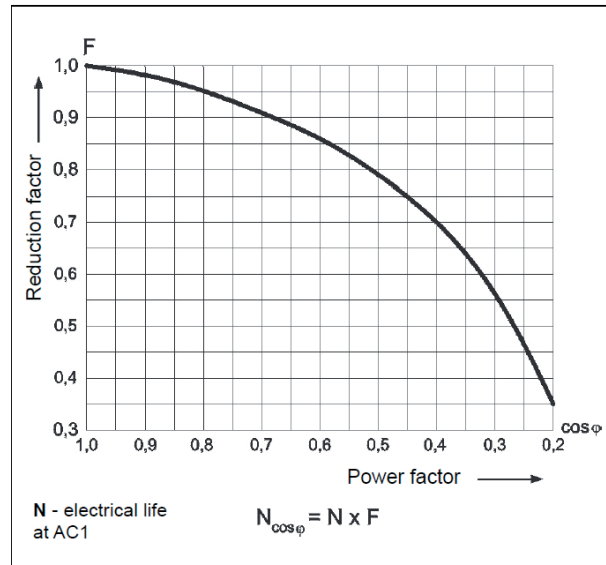

Max. DC breaking capacity Fig. 3
 A - resistive load DC1
 B - inductive load L/R = 40 ms

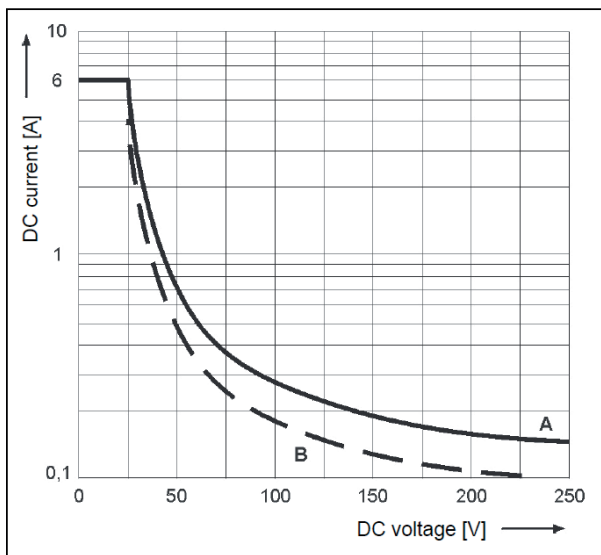

General purpose relay

M-relay

Sockets



Art. no.	Type	Applicable for	Connection	Weight (g)	Dimensions (mm)
321000520	VM-2R	M2 relays, 35 mm rail or wall	Screw terminals	61	76.3 x 27 x 42.5
321000510	VM-3R	M3 relays, 35 mm rail or wall	Screw terminals	61	76.3 x 27 x 42.5
321000519	VM-4R	M4 relays, 35 mm rail or wall	Screw terminals	61	76.3 x 27 x 42.5
321000521	VM-2L	M2 relays, 35 mm rail or wall	Screw terminals	71	75 x 27 x 61
321000511	VM-3L	M3 relays, 35 mm rail or wall	Screw terminals	71	75 x 27 x 61
321000512	VM-4L	M4 relays, 35 mm rail or wall	Screw terminals	71	75 x 27 x 61
321000516	VM-4	M2 & M4 relays, 35 mm rail or wall	Screw terminals	55	67 x 30 x 29
321000513	VM-4CC	M2 & M4 relays, 35 mm rail or wal	Screw & clamp terminal	74	95 x 31 x 42.5
321000514	VM-2PCB	M2 relays	PCB	6	30 x 22 x 11
321000515	VM-4PCB	M4 relays	PCB	6	30 x 22 x 11

Accessories



Art. no.	Type	Applicable for	Weight (g)
321000509	MS-35	Relay retaining clip, plastic	4
321000503	CM-1	Relay retaining clip, metal	0.5
321000522	DMP-1	Description plate	0.4
321000523	M-connector-5	Interconnection strip	6.5

General purpose relay

M-relay

Accessories

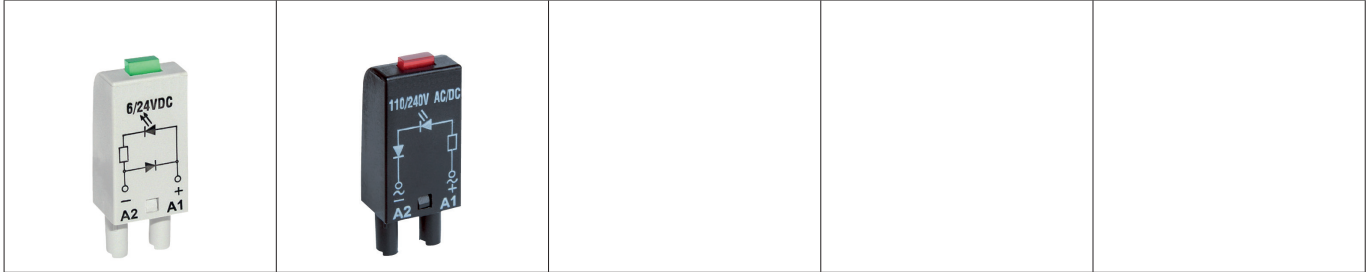

Type	Schematic	Voltage	Art.no.	LED colour
DM-1 Limits overvoltage on DC coils	- A2 + A1	6...230 VDC	321000507	
DM-2 Limits overvoltage on DC coils	+ A2 - A1	6...230 VDC	321000524	
VM-8 Limits overvoltage on AC coils No indication	A2 A1	6...24 VAC 110...240 VAC	321000552 321000554	

General purpose relay **M-relay**

Installation, operation, maintenance

Installation

- Install the socket and connect wiring according the identification on the terminals, plug the relay into the socket
- Reverse installation of socket is not possible due to mechanical blocking by pinning
- Do not reverse the polarity of the coilconnection when a diode is used
- Relays can be mounted tight next to each other
- Warning! Never use silicon near by relays!

Operation

- Before operate always apply voltage to coil to check correct operation
- Also switching the load a few times is advised
- Long term storage may corrode the silver on the relay pins
- By plugging the relay into the socket, the connector receivers will automatically clean the corrosion on the pins and guarantee a good connection
- Do not use the relay in places with flammable gas as the arc generated from switching could ignite gasses

Maintenance

- Correct operation of relay can easily be checked as transparent cover gives good visibility on the moving contacts
- When the relay does not appear to operate correct, please check presence of coil voltage
- Use a multimeter.
- If LED is used coil presence should be indicated, if coil voltage is present but the relay does not work, a short circuit of suppression diode is possible (The coil connection was reversed)
- If relay does not work after inspection, please replace the relay by a similar model

General purpose relay

M-relay

Ordering codes

M2 relays

M2-D012	12 VDC	321000301
M2-D024	24 VDC	321000302
M2-D048	48 VDC	321000303
M2-D110	110 VDC	321000304
M2-D125	125 VDC	321000310
M2-D220	220 VDC	321000311
M2-A012	12 VAC, 50/60 Hz	321000305
M2-A024	24 VAC, 50/60 Hz	321000306
M2-A048	48 VAC, 50/60 Hz	321000307
M2-A110	110 VAC, 50/60 Hz	321000308
M2-A230	230 VAC, 50/60 Hz	321000309

M2-L relays (+LED)

M2-L-D012	12 VDC	321000351
M2-L-D024	24 VDC	321000352
M2-L-D048	48 VDC	321000353
M2-L-D110	110 VDC	321000354
M2-L-D125	125 VDC	321000360
M2-L-D220	220 VDC	321000361
M2-L-A012	12 VAC, 50/60 Hz	321000355
M2-L-A024	24 VAC, 50/60 Hz	321000356
M2-L-A048	48 VAC, 50/60 Hz	321000357
M2-L-A110	110 VAC, 50/60 Hz	321000358
M2-L-A230	230 VAC, 50/60 Hz	321000359

* other voltages on request

M3 relays

M3-D012	12 VDC	321001001
M3-D024	24 VDC	321001002
M3-D048	48 VDC	321001003
M3-D110	110 VDC	321001004
M3-D125	125 VDC	321001010
M3-D220	220 VDC	321001011
M3-A012	12 VAC, 50/60 Hz	321001005
M3-A024	24 VAC, 50/60 Hz	321001006
M3-A048	48 VAC, 50/60 Hz	321001007
M3-A110	110 VAC, 50/60 Hz	321001008
M3-A230	230 VAC, 50/60 Hz	321001009

General purpose relay M-relay

Ordering codes

M3-L relays (+LED)

M3-L-D012	12 VDC	321001151
M3-L-D024	24 VDC	321001152
M3-L-D048	48 VDC	321001153
M3-L-D110	110 VDC	321001154
M3-L-D125	125 VDC	321001160
M3-L-D220	220 VDC	321001161
M3-L-A012	12 VAC, 50/60 Hz	321001155
M3-L-A024	24 VAC, 50/60 Hz	321001156
M3-L-A048	48 VAC, 50/60 Hz	321001157
M3-L-A110	110 VAC, 50/60 Hz	321001158
M3-L-A230	230 VAC, 50/60 Hz	321001159

* other voltages on request

M4 relays

M4-D012	12 VDC	321000401
M4-D024	24 VDC	321000402
M4-D048	48 VDC	321000403
M4-D110	110 VDC	321000404
M4-D125	125 VDC	321000410
M4-D220	220 VDC	321000411
M4-A012	12 VAC, 50/60 Hz	321000405
M4-A024	24 VAC, 50/60 Hz	321000406
M4-A048	48 VAC, 50/60 Hz	321000407
M4-A110	110 VAC, 50/60 Hz	321000408
M4-A230	230 VAC, 50/60 Hz	321000409

M4-L relays (+LED)

M4-L-D012	12 VDC	321000451
M4-L-D024	24 VDC	321000452
M4-L-D048	48 VDC	321000453
M4-L-D110	110 VDC	321000454
M4-L-D125	125 VDC	321000460
M4-L-D220	220 VDC	321000461
M4-L-A012	12 VAC, 50/60 Hz	321000455
M4-L-A024	24 VAC, 50/60 Hz	321000456
M4-L-A048	48 VAC, 50/60 Hz	321000457
M4-L-A110	110 VAC, 50/60 Hz	321000458
M4-L-A230	230 VAC, 50/60 Hz	321000459

* other voltages on request

General purpose relay
M-relay

 **Over 10 million Mors Smitt relays in use in applications worldwide!**

Mors Smitt Asia Ltd.
Unit B & C, 25/F., Casey Aberdeen House
38 Heung Yip Road, Wong Chuk Hang
Hong Kong
Tel: +852 2343 555
sales.msa@wabtec.com

Mors Smitt France SAS
2 Rue de la Mandinière
72300 Sablé-sur-Sarthe, France
Tel: +33 (0) 243 92 82 00
sales.msfr@wabtec.com

Mors Smitt UK Ltd.
Graycar Business Park,
Burton on Trent, DE13 8EN, UK
Tel: +44 (0)1283 357 263
sales.msuk@wabtec.com

Wabtec Netherlands B.V.
Darwinstraat 10,
6718 XR Ede, Netherlands
Tel: +31 (0)88 600 4555
sales.msbv@wabtec.com

Mors Smitt Technologies Ltd.
1010 Johnson Drive,
Buffalo Grove, IL 60089-6918, USA
Tel: +1 847 777 6497
salesmst@wabtec.com

RMS Mors Smitt
19 Southern Court,
Keysborough, VIC 3173, Australia
Tel: +61 (0)3 8544 1200
sales.rms@wabtec.com

(c) Copyright 2021

All rights reserved. Nothing from this edition may be multiplied, or made public in any form or manner, either electronically, mechanically, by photocopying, recording, or in any manner, without prior written consent from Mors Smitt. This also applies to accompanying drawings and diagrams. Due to a policy of continuous development Mors Smitt reserves the right to alter the equipment specification and description outlined in this datasheet without prior notice and no part of this publication shall be deemed to be part of any contract for the equipment unless specifically referred to as an inclusion within such contract. Mors Smitt does not warrant that any of the information contained herein is complete, accurate, free from potential errors, or fit for any particular purpose. Mors Smitt does not accept any responsibility arising from any party's use of the information in this document.