

A 400 relay - 4 contacts

Datasheet

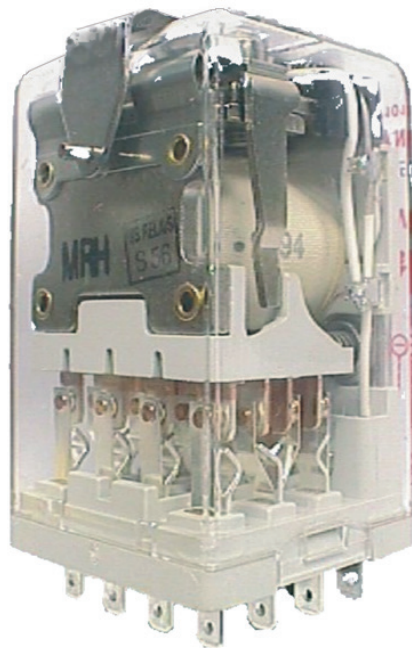

Description

The A 400 relay has 4 double make / double break C/O contacts (form Z). The plug-in design offers secure locking feature for maximum ease of maintenance (no wires need to be disconnected or other hardware removed for relay inspection or replacement).

The resistance to impact and vibration is conforming the standards for Railway Transported Equipment. Positive mechanical keying of relay to socket is built into relay and socket during manufacture and terminal identifications are clearly marked on identification plate that is permanently attached to the relay.

The A 400 relays is pluggable in the following sockets: EA 102 A, EA 102 AF, EA 103 AF, EA 104 A, EA 104 AF, EA 105 AF, EA 112 AF.

Application

The A 400 relay is designed for general purpose heavy duty applications such as lighting, pumps and fans, offering as an option a weld no transfer design for safety critical applications such as door control, emergency brake failure, interlocking traction and breaking

Features

- Instantaneous relay
- Optional weld no transfer contacts for safety critical applications
- Plug-in design with secure locking feature for maximum ease of maintenance
- 4 double make / double break C/O contacts (form Z), 8 A
- Contact life (mechanical) of 100 million cycles
- -40 °C...+80 °C operating temperature

Benefits

- Proven reliable in heavy duty application
- Long life cycle
- Easy to maintain and replace
- Low life cycle cost
- No maintenance

Railway compliancy

- NF F 62-002 Rolling stock- Instantaneous relays contacts and sockets
- NF F16-101/102 Fire behaviour - Railway rolling stock



A 400 relay

Technical specifications

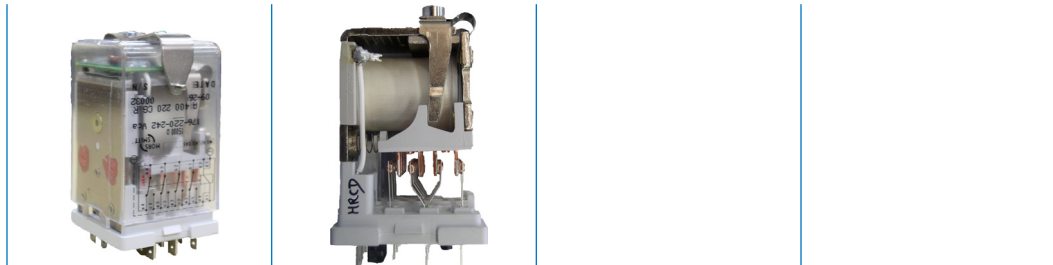

Functional and connection diagrams

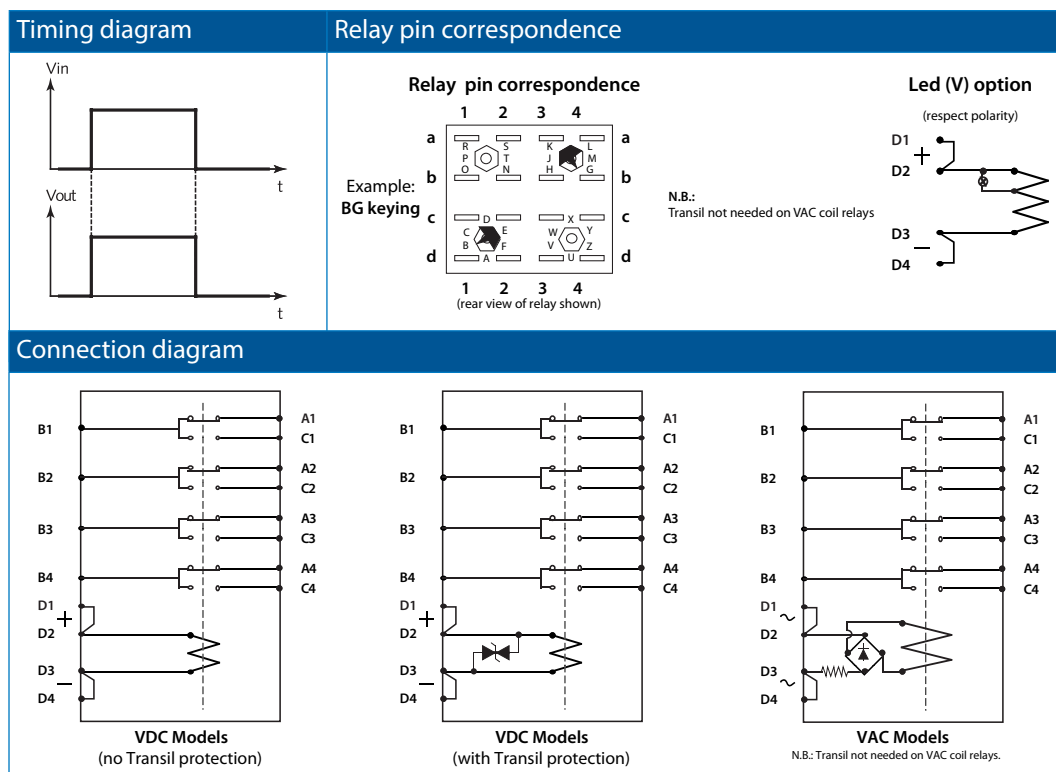

A 400 relay

Technical specifications

Coil data - DC versions

Keying	Unom (VDC)	Uoperating (VDC)	Pnom (W)	Uhold (VDC)	Udrop-out (VDC)	R coil (Ω) ⁽¹⁾	L/R (ms) ⁽²⁾
ME	12	8 / 16	3	6.25	1.25	48	30
AG	24	16 / 33	3	13.5	2.5	185	30
FL	36	25 / 45	3	21	3.5	430	30
DG	48	33 / 60	3	28.5	4.5	750	30
BG	72	48 / 90	3	40.5	6.5	1700	30
US	96	65 / 120	3	50	9	3000	30
SV	110	75 / 138	3	62	10	4000	30
EG	125	88/156	3	73	12	5700	30

(1) Coil resistance tol.: $\pm 8\%$ at 20 °C

(2) Valid for closed relay.

Coil data - AC versions

Keying	Unom (VAC)	Uoperating (VAC)	Pnom (VA)	Uhold (VAC)	Udrop-out (VAC)	R coil (Ω) ⁽¹⁾	L/R (ms) ⁽²⁾
SZ	115	80 / 140	3	65	10	4000	30
CG	220	176 / 242	3	129	21	15000	30

(1) Coil resistance tol.: $\pm 8\%$ at 20 °C

(2) Valid for closed relay.

Contact data – standard version (Ag contacts)

Nominal current	8 A resistive		
Nominal breaking capacity and life	1 A at 72 VDC	L/R : 0 ms	Electrical life: 5×10^6 op.
Nominal breaking capacity and life	350 mA at 72 VDC	L/R: 30 ms	Electrical life: 2.5×10^6 op.
Nominal breaking capacity and life	1 A at 220 VAC - 50 Hz,	$\cos\phi=1$	Electrical life: 2.5×10^6 op.
Nominal breaking capacity and life	Lamp filament circuit: 120 W at 72 VDC		Electrical life: 5×10^5 op.
Contact overload withstand	At 24 VDC: 100 A at L/R = 0 for 10 ms (10 operations at the rate of 1 operation per minute)		
Contact closure time	Pick-up time N/O < 40 ms	Drop-out* time N/C: < 15 ms	
Contact opening time	Pick-up time N/C < 35 ms	Drop-out* time N/O: < 6 ms	
Minimum contact continuity	20 mA at 24 VDC		
Number of contacts	4 double make / double break contacts (form Z)		
Contact material	Hard silver overlay laminated to copper		
Contact resistance – initial	10 m Ω max at 5 A		
Contact resistance – end of life	40 m Ω max at 5 A		

* With P option less than 70 ms



A 400 relay

Technical specifications

Contact design

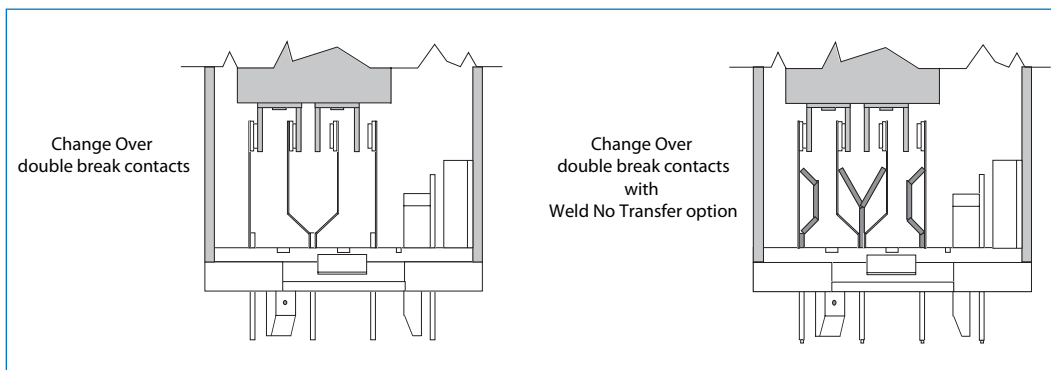

Electrical characteristics

Dielectric strength	2000 VAC, 1 min between contacts, 2600 VAC, 1 min between contacts, coil and frame
Insulation resistance	≥ 1000 MΩ at 500 VDC

Mechanical & environmental characteristics

Vibration	NF F 62-002 The tests are conducted in the X, Y , Z planes at frequency between 10 & 150 cycles (sinusoidal) at 2 g.
Shock	NF F 62-002 Tests are applied in both directions in the X, Y & Z planes. Then successive shocks are administered consisting of the positive component of sinusoidal with a value of 30 g, 18 ms. Other vibration and shock tests can be performed on request
Mechanical life	> 100 x 10 ⁶ operations
Weight	300 g
Temperature	-40 °C ...+80 °C
Humidity	93% RH, 40° C for 4 days
Salt mist	5% NaCl, 35° C for 4 days
Protection	IP40
Fire & smoke	Materials: Polycarbonate (cover) / Polyester Melamine (base) Note: These materials have been tested for fire propagation and smoke emission according to standards NF F 16-101, NF F 16-102, ASTM E162 and ASTM E662, and have been approved to be used on the English/French train channel shuttle.



A 400 relay

Technical specifications

Dimensions (mm)

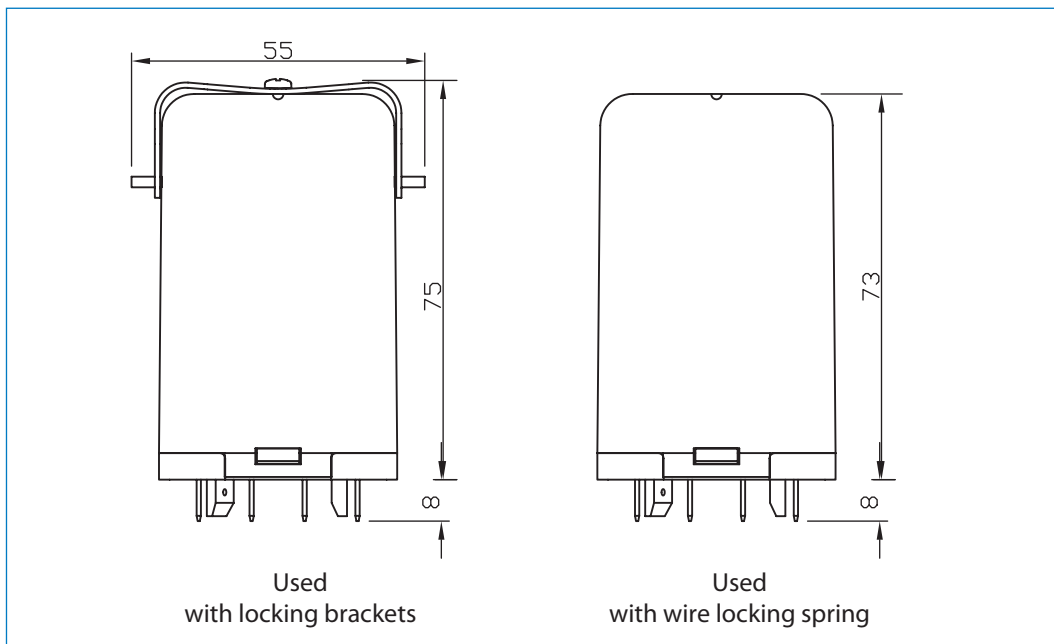

Keying

Socket (top view)
Keyed for BG (72 VDC)

Round plug Hexagonal key (typical)

Keying of relay to socket is accomplished by pressing 2 hexagonal keys and 2 round plugs into molded-in recesses on the Socket. Relay keying done in factory.

Insert keys so that arrows point to the correct keying letters on Socket - see example shown.

Faston socket EA 104 shown. Screw type socket EA 103, front single faston EA 105 and double Faston EA 102 are keyed similarly.

Hexagonal plastic key

Round plastic plug

(empty molded recesses are filled up by pressing 2 round plastic plugs)



A 400 relay

Technical specifications

Dynamic relay selection curve No 1

AC Current breaking capacity versus life expectancy in millions of cycles.
 Rate of contacts opening and closing = 1200 operations per hour.
 Curves shown for resistive load (Power Factor = 1).

Curve	1	2	3	4
VAC	220	125	48	24

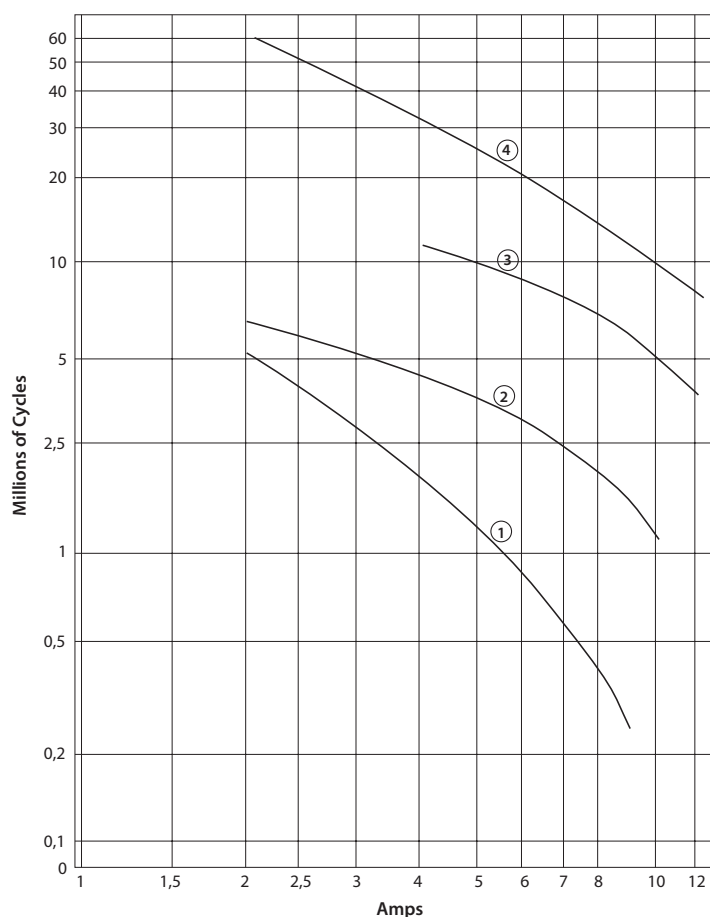

A 400 relay

Technical specifications

Dynamic relay selection curve No 2

DC Current breaking capacity versus life expectancy in millions of cycles.

Rate of contacts opening and closing = 1200 operations per hour.

Curves shown for inductive load:

- L/R= 20 ms continuous current
- - - - L/R= 40 ms continuous current

* By connecting 2 contacts in series, DC current breaking capacity increases by 50 %

Curves	1-3	2-4	5-6	7-8
VDC	220	125	48	24

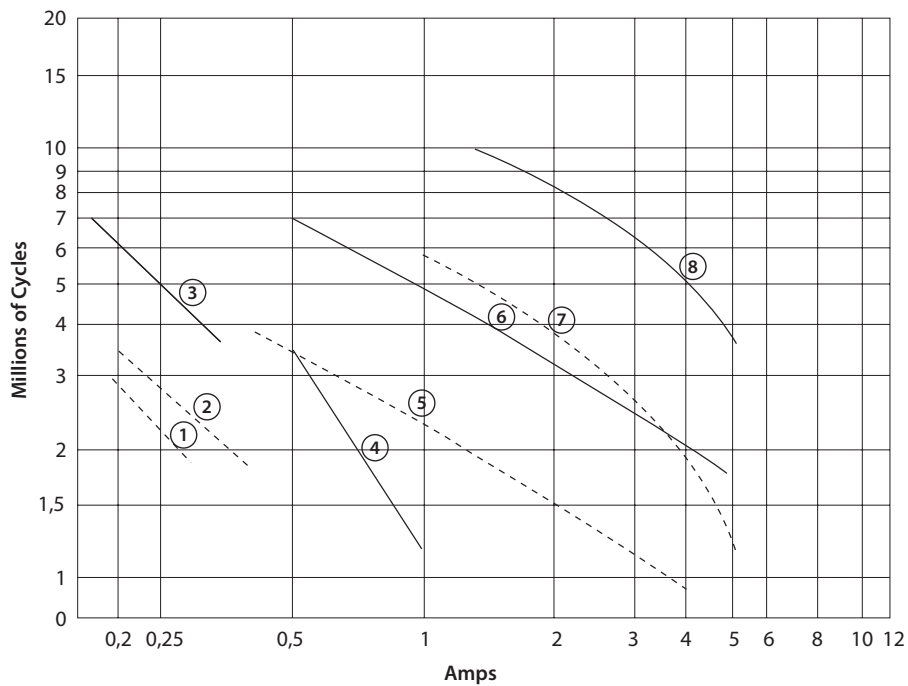

A 400 relay

Technical specifications

Dynamic relay selection curve No 3

DC Current breaking capacity versus life expectancy in millions of cycles.

Rate of contacts opening and closing = 1200 operations per hour.

Curves shown for resistive load (L/R = 0). Continuous current.

* By connecting 2 contacts in series, DC current breaking capacity increases by 50 %

Curve	1	2	3	4
VDC	220	125	48	24

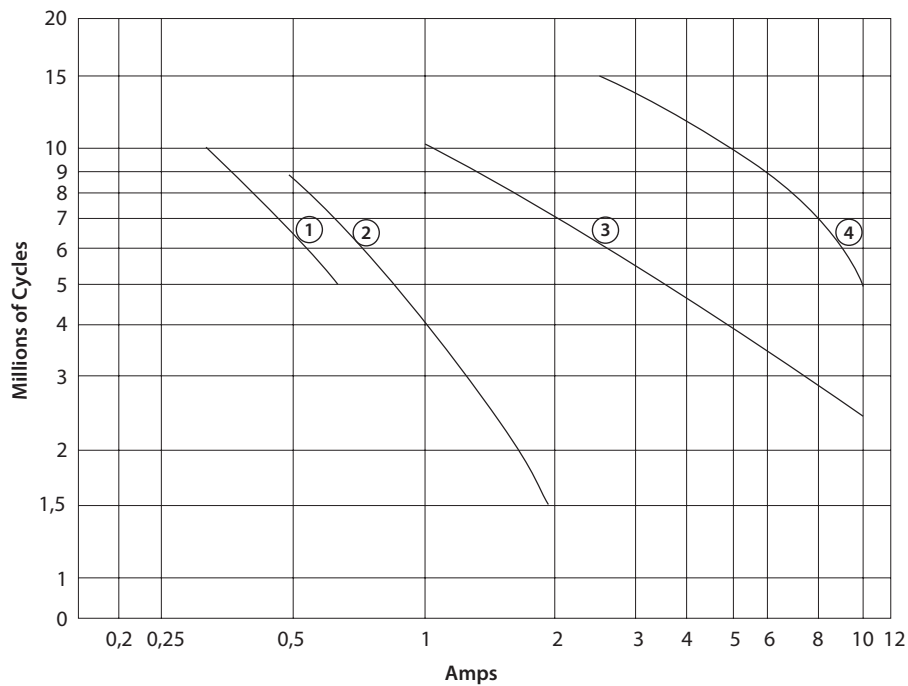

A 400 relay

Technical specifications

Dynamic relay selection curve No 4

Maximum contact breaking capacity versus voltage for a given L/R.

Rate of contacts opening and closing = 600 operations per hour.

Curves shown for resistive load (L/R=0) and inductive loads. Continuous current.

Life expectancy: 2 Millions of Cycles

Curve	1	2	3	4	5	6
L/R=	0ms	15ms	20ms	40ms	60ms	100ms

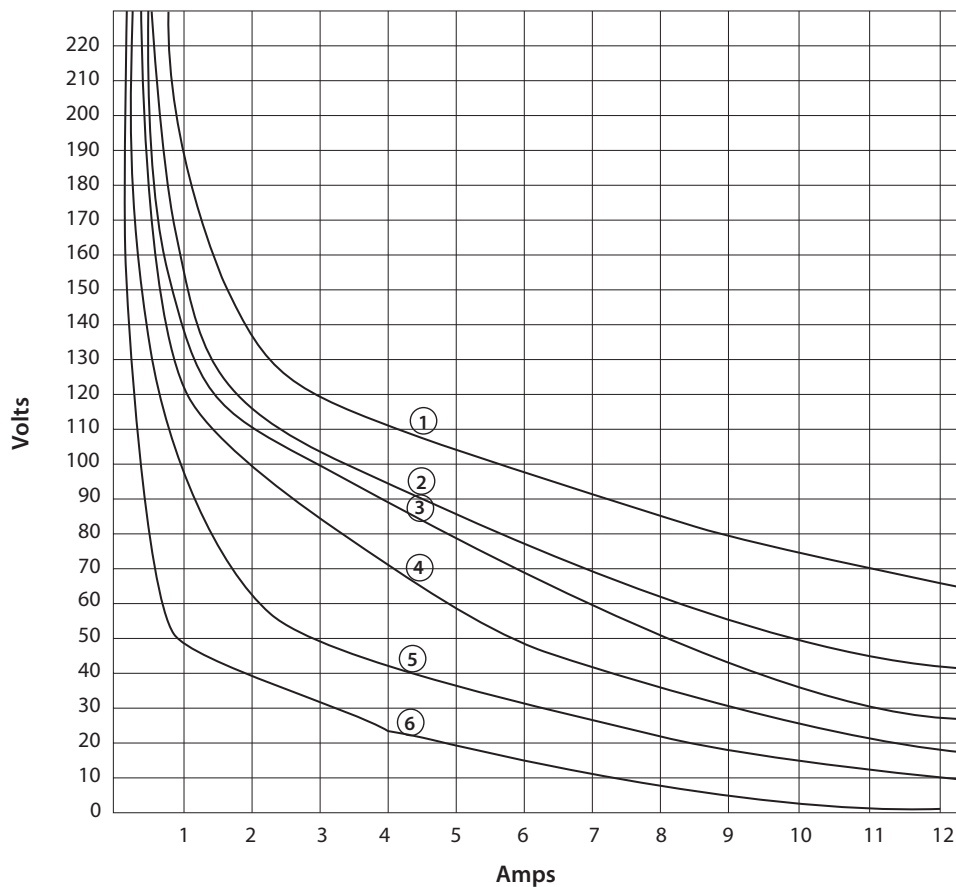

A 400 relay

Technical specifications

Dynamic relay selection curve No 5

Maximum power interruption versus load time constant (L/R) for a given voltage.
Curves shown for resistive loads. $I = P/V$.

Curve	1	2	3	4	5
VDC	220	125	72	48	24

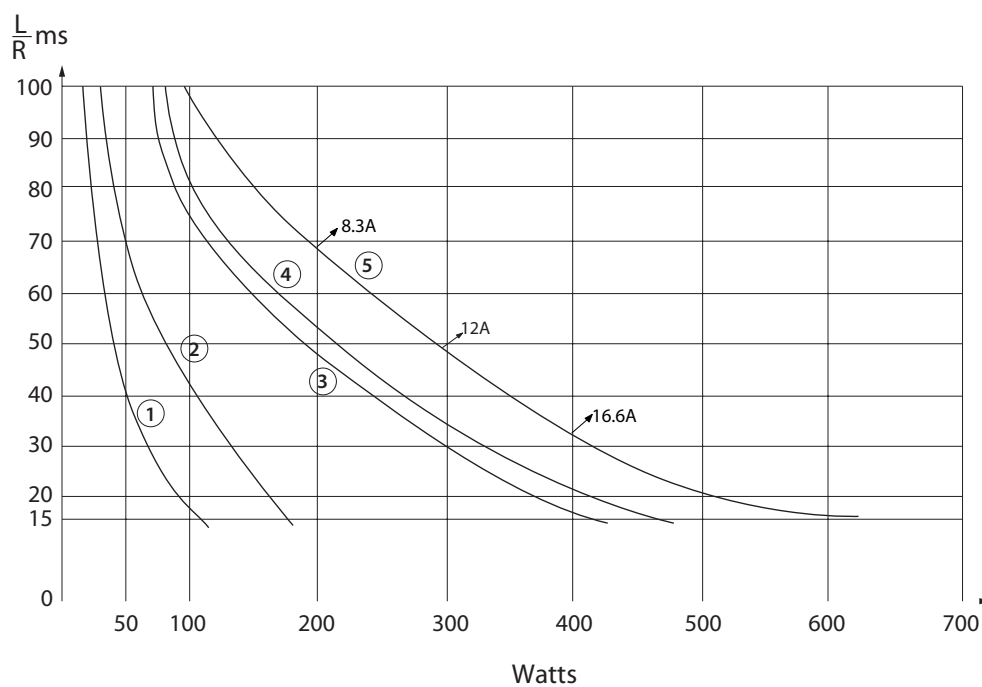

A 400 relay

Technical specifications

Dynamic relay selection curve No 6

AC Current breaking capacity versus life expectancy in millions of cycles.

Rate of contacts opening and closing = 1200 operations per hour.

Values shown for inductive loads -

——— Cos $\varnothing = 0.7$

----- Cos $\varnothing = 0.5$

----- Cos $\varnothing = 0.3$

Curves	1,3 &4	2,5 &7	6,9 &10	8,11 &12
VAC	220	125	48	24

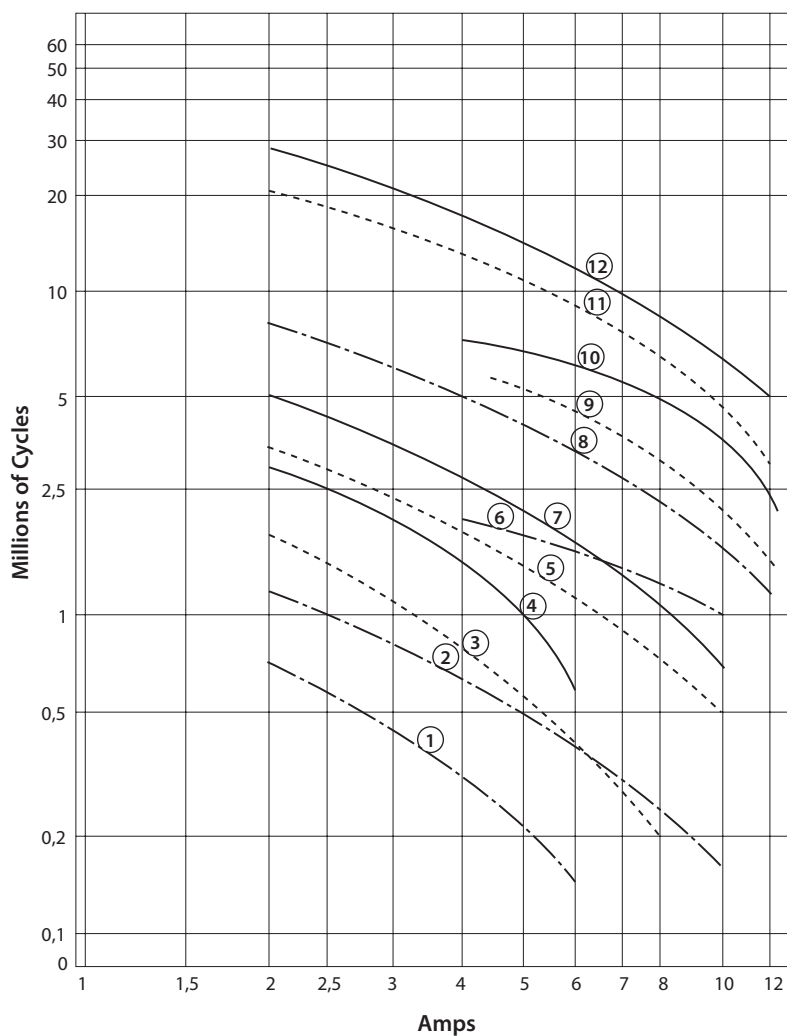

A 400 relay

Mounting possibilities

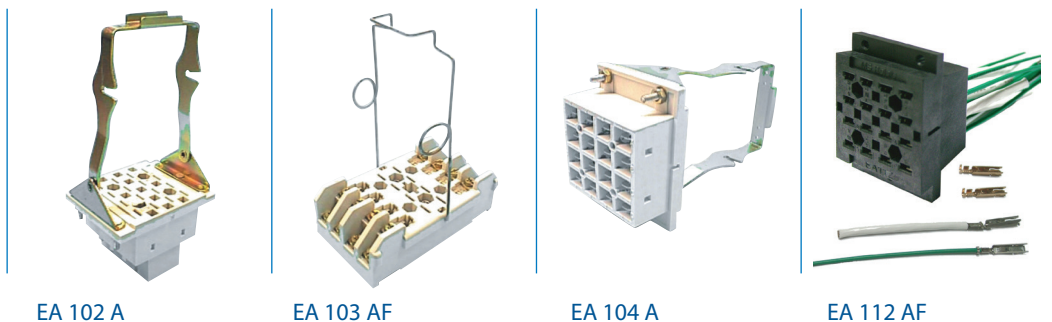

Mounting possibilities/sockets

Panel/flush mounting

EA 102 A	Locking bracket (905843), rear connection, double Faston 5 mm (3/16")
EA 102 AF	Wire locking spring (926853), rear connection, single Faston 5 mm (3/16")
EA 104 A	Locking bracket (905843), rear connection, single Faston 5 x 0.8 mm
EA 104 AF	Wire locking spring (926853), rear connection, single Faston 5 x 0.8 mm
EA 112 AF	Wire locking spring (926853), rear connection, crimp contact

Surface/wall mounting

EA 103 AF*	Wire locking spring (926853), front connection, M3 screw 6,5 mm ring terminals (2,5 mm ²)
EA 105 AF*	Wire locking spring (926853), front connection, single Faston 5 mm (3/16")

* Mounting possibility on 35mm rail EN 50022 by adding suffix D to the part number (see socket datasheet)



Note: Keying of relay to socket can be specified by adding the keying letters in the part number.
See all details in the related socket datasheet.



A 400 relay

Spare parts

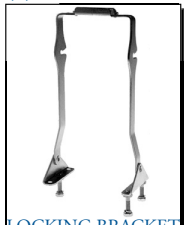
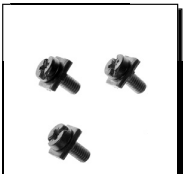
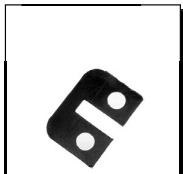
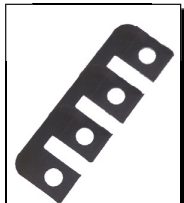
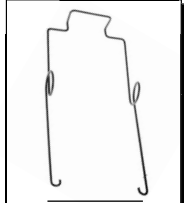
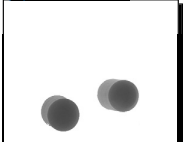
Spare parts - order part numbers

<p>(1)</p>  <p>LOCKING BRACKET 905843</p>	<p>(1)</p>  <p>SCREW FOR BRACKET C927210</p>	<p>(1)</p>  <p>METAL STRAP (2) P928060</p>	<p>(1)</p>  <p>METAL STRAP (4) P928061</p>
<p>(1)</p>  <p>WIRE LOCKING SPRING 926853</p>	<p>(1)</p>  <p>ROUND PLASTIC PLUGS 414928005</p>	<p>(2)</p>  <p>HEX. PLASTIC KEYS 414905678</p>	<p>(3)</p>  <p>LOCK PINS ASSY 2 SCREWS 906364 212903020</p>

(1) Parts only for socket
 (2) Parts for relay and socket
 (3) Parts only for relay



A 400 relay

User specifications

Installation

Install socket and connect wiring correctly according identification to terminals. Plug relay into socket. Reverse installation into socket not possible due to mechanical blocking by snap-lock.
Don't reverse polarity of coil connection. Relays can be mounted (tightly) next to each other and in any attitude.
Warning! Never use silicon near by relays

Operation

Before operating always apply voltage to coil to check correct operation.
Long term storage may corrode the silver on the relay pins. Just by plugging the relay into the socket, the female bifurcated receivers will automatically clean the corrosion on the pins and guarantee a good connection.
Do not use the relay in places with flammable gas as the arc generated from switching could ignite gasses.

Maintenance

Correct operation of relay can easily be checked as transparent cover gives good visibility on the moving contacts. When the relay doesn't seem to operate correct, please check presence of coil voltage. Use a multimeter. If LED is used, coil presence should be indicated. If coil voltage is present, but the relay doesn't work, a short circuit of suppression diode is possible (The coil connection was reversed). If relay doesn't work after inspection, please replace relay unit by a similar model. Send defective relay back to manufacturer. Normal wear and tear excluded.



A 400 relay

Ordering Scheme



- | | | | | | | |
|----------------|--------------------|-----------|-------------|---------------------|------------------|---------------|
| 1. Relay model | 2. Nominal voltage | 3. Keying | 4. Coil OVP | 5. Weld no transfer | 6. LED indicator | 7. Cover type |
|----------------|--------------------|-----------|-------------|---------------------|------------------|---------------|

This example represents a A 400 24 AG S C V F.
 Description: A 400 series relay, Unom: 24 VDC, Keying AG, transil coil protection, weld no transfer, LED indicator, relay cover for wire locking spring

1. Relay model

A 400

2 & 3. Nominal voltage and keying

AG	24 VDC
FL	36 VDC
DG	48 VDC
BG	72 VDC
US	96 VDC
SV	110 VDC
EG	125 VDC
SZ	115 VAC
CG	220 VAC

4. Coil overvoltage protection

-	No coil protection
P	Avalanche diode coil protection
S	Transil coil protection
Note: no protection for AC coil versions	

6. LED coil voltage indicator

-	No LED
V	LED voltage indicator

5. Weld no transfer option

-	Regular double-break contacts
C	Weld no transfer

7. Relay cover type

-	Relay cover with lock pins
F	Relay cover for wire locking spring





DS-A 400-V2.1 July 2016

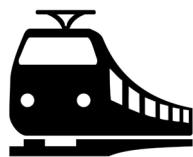

www.morssmitt.com



Mors Smitt France SAS

Tour Rosny 2, Avenue du Général de Gaulle,
F - 93118 Rosny-sous-Bois Cedex, FRANCE
T +33 (0)1 4812 1440, F +33 (0)1 4855 9001
E sales.msf@wabtec.com

Mors Smitt Asia Ltd.

29/F, Fun Towers, 35 Hung To Road
Kwun Tong, Kowloon, HONG KONG SAR
T +852 2343 5555, F +852 2343 6555
E sales.msa@wabtec.com

Mors Smitt B.V.

Vrieslantlaan 6, 3526 AA Utrecht,
NETHERLANDS
T +31 (0)30 288 1311, F +31 (0)30 289 8816
E sales.msbv@wabtec.com

Mors Smitt Technologies Inc.

1010 Johnson Drive,
Buffalo Grove, IL 60089-6918, USA
T +1 847 777 6497, F +1 847 520 2222
E salesmst@wabtec.com

Mors Smitt UK Ltd.

Graycar Business Park, Barton under Needwood,
Burton on Trent, Staffordshire, DE13 8EN, UK
T +44 (0)1283 722650 F +44 (0)1283 722651
E sales.msuk@wabtec.com

RMS Mors Smitt

6 Anzed Court, Mulgrave,
VIC 3170, AUSTRALIA
T +61 (0)3 8544 1200 F +61 (0)3 8544 1201
E sales.rms@wabtec.com

(c) Copyright 2016

All rights reserved. Nothing from this edition may be multiplied, or made public in any form or manner, either electronically, mechanically, by photocopying, recording, or in any manner, without prior written consent from Mors Smitt. This also applies to accompanying drawings and diagrams. Due to a policy of continuous development Mors Smitt reserves the right to alter the equipment specification and description outlined in this datasheet without prior notice and no part of this publication shall be deemed to be part of any contract for the equipment unless specifically referred to as an inclusion within such contract. Mors Smitt does not warrant that any of the information contained herein is complete, accurate, free from potential errors, or fit for any particular purpose. Mors Smitt does not accept any responsibility arising from any party's use of the information in this document.