

TEST BLOCKS | TEST PLUGS | TEST LEADS

# 28 Circuit Test Block System 4M402

Flexible and high performance test block system with a focus on operator safety.  
Suitable for application on a wide range of protection relay panels.

- > Finger safe test sockets
- > Automatic CT shorting
- > 28 independent test groups
- > Custom specified test circuits
- > Made in Australia



## System Components

- > 28 test circuits may be specified in any configuration
- > 'Finger safe' test sockets
- > Multi finger test plug



4M402 Test block



4M422 Multi finger test plug

## Features

- > 'Finger safe' test sockets suit standard or shrouded type 4mm banana plugs for direct access to the protection or measurement scheme
- > 28 independent test groups may be specified with any combination of circuit types
- > Automatic shorting of CT circuits completed in the test block - No test links or operator intervention required
- > Isolation plug provides sequential circuit isolation timing in three (3) stages
- > Clear and concise front panel circuit identification
- > Test plug fitted with insertion handle and thumb screw retention system to enhance operator safety and system security
- > Side label instructions on test plug for changing from normal service to the test condition
- > High current / voltage rating
- > Made in Australia

## Application

Test blocks enable test technicians to quickly and safely isolate protection relays so that test signals may be injected and system performance verified.

There are a number of advantages in performing injection tests at the protection relay panel:

- > Reduction in down time of the equipment under test
- > Testing does not cause disturbance to wiring, terminals or equipment settings
- > Existing auxiliary supply to the equipment under test may be isolated

The 4M402 Test Block is designed as a general-purpose isolation and test signal injection point. 'Finger safe' sockets are employed to improve operator safety and suit 4mm shrouded 'finger safe' type banana plugs.

Equipment under test need only be removed for servicing if problems are detected or for routine maintenance.

Where up to 14 test circuits are required refer to the 4M400 model that provides 14 test circuits.



## Test Circuit Access

Access to the circuits, for testing purposes, is achieved in a three stage process.

<b>STAGE I</b>	Test Block Cover Extraction	
Isolation	Isolation of Type 1 circuits	
<b>STAGE II</b>	Isolation Plug Extraction	
CT Shorting	Automatic shorting of all CT circuits	
Isolation	Isolation of Type 3 circuits	Isolation of Type 2, 8 and 9 circuits
<b>STAGE III</b>	Test Plug Insertion	
Insertion	4mm Test Sockets available	

The above procedure should be completed in the reverse order to place the protection system back in service.

Insertion of the Test Plug type 4M422 connects the live side circuits to the 4mm yellow test sockets. The equipment side circuits are connected to the 4mm black test sockets. Each test socket is identified by a number, which corresponds to the numbered terminal on the rear of the case when the Test Plug is inserted. Refer to figure 4.

## Description

The 4M402 Test Block is an evolution of our popular 4M400 system. The main difference is that twenty-eight (28) test groups may be specified at time of order to provide automatic CT shorting and sequential circuit isolation to suit specific protection schemes:

- > Auxiliary supply isolation
- > CT shorting
- > Trip isolation
- > General circuit isolation

The main advantage of this approach is the improved level of safety and security afforded to the CT circuits. This is because the CT shorting function takes place within the 4M402 Test Block irrespective of the CT circuit position. In many test block systems, the CT shorting is only accomplished when the Test Plug is inserted which leaves open the possibility of a CT circuit becoming open circuit due to the CT shorting links being omitted or in the wrong position. This potential problem is negated in the 4M402 and allows a single model 4M422 Test Plug to be employed for all 4M402 Test Block configurations. Each test circuit is connected to a separate pair of terminals at the rear of the case. During normal operation of the associated protection equipment, each terminal pair is connected via a circuit-shortening link.

Changing the 4M402 Test Block from the normal service condition occurs in three (3) stages as depicted in the timing diagram figure 1.

Where up to 14 test circuits are required, the 4M400 Test Block with 14 test circuits may be employed.

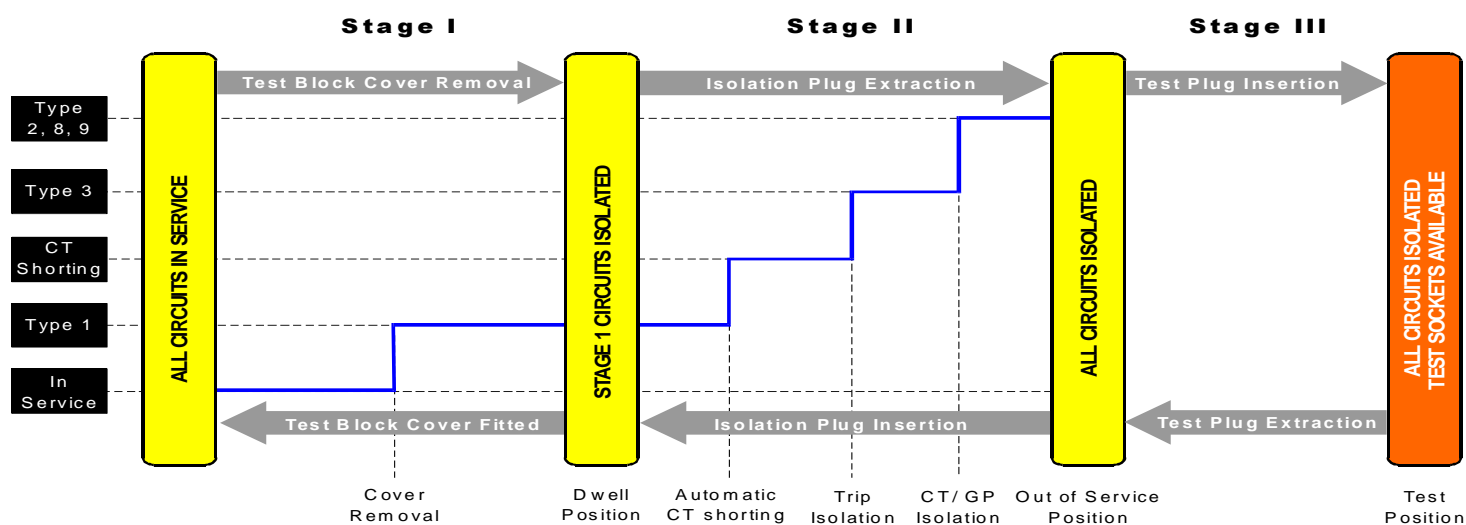

## Safety Overview

While providing considerable convenience and efficiencies to system testing, test block systems must provide a high degree of safety. This section describes the key design features employed in the 4M402 test block system to enhance operator safety.

## Finger Safe Test Sockets

**BLACK** - Equipment side sockets

**YELLOW** - Live side sockets



Figure 2: Close up view of the 'finger safe' test plug sockets that accept standard 4mm shrouded test plugs

The 4M422 Test Plug employs 'finger safe' test sockets. This allows the use of shrouded 'finger safe' banana plugs to greatly reduce the possibility of an operator coming into contact with any part of the test circuit.

## Test Plug Handles

The 4M422 employs handles at the top and bottom of the plug assembly to ensure the operators hand is well separated from the test sockets during insertion. Retention thumb screws are provided at the top and bottom of the test plug to avoid inadvertent removal of the plug during testing.



Figure 3:

## 14 Test Circuit Versions

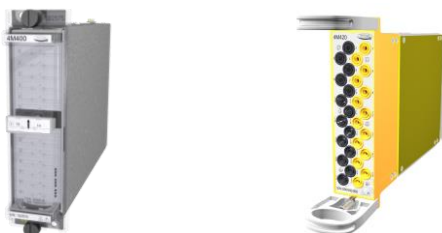

Figure 4:

4M400 Test block

4M420 Multi finger test plug

## Automatic CT Shorting

In traditional test block systems CT shorting is achieved by the operator manually fitting shorting links to the appropriate positions before inserting the test plug. This can lead to serious errors due to incorrect or poorly interpreted wiring diagrams.

The 4M402 Test Block system employs a fool proof method of CT shorting. When the 4M402 Isolation Plug is removed the CT shorting is accomplished automatically within the test block irrespective of the CT position or test block configuration. The 4M422 Test Plug does not require any special configuration before insertion as the CT shorting positions have already been specified at the time of order to suit a particular wiring arrangement.

## Test Block Polarization

Where conventional test block wiring schemes are employed in a protection panel, sub-station or indeed across a power utility network, there exists the possibility of a test plug being inserted into the wrong test block. The 4M402 Test Block avoids the potential for operator error as it incorporates a polarization pin so that only the 4M402 Isolation Plug and 4M422 Test Plug may be inserted.

## Test Lead Insertion

Before use the insulation of the flying leads should be visibly checked for damage.



Flexible banana test leads with shrouded plugs are recommended for operator safety. 2.5mm<sup>2</sup> multi-strand wire with PVC insulation is recommended for adequate current rating and flexibility.

## Test Plug Insertion

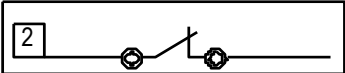

To avoid high voltage shock hazard external CT circuits must NOT be open circuited.

Insertion of the 4M422 connects the live side circuits to the YELLOW test sockets on the front panel. The equipment side circuits are connected to the BLACK test sockets on the front panel. Each test socket is identified by a number, which corresponds to the numbered terminal on the rear of the case when the Test Plug is inserted.

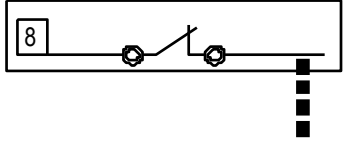
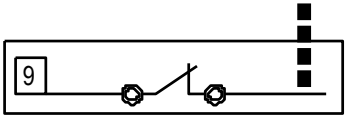
Type	Description	Function	Front Panel Labeling
0	Blank circuit	To allow additional space for labeling on the front panel and isolation to adjacent test circuits. May be specified where less than 28 test circuits are required.	CUSTOM TEXT (2 lines x 15 characters)
1	Test Block Cover	This circuit type is isolated at Stage I as the front cover is removed from the Test Block. Use to provide: <ul style="list-style-type: none"> <li>• Isolation of auxiliary supply</li> <li>• Isolation of trip circuits</li> </ul>	
2	General Purpose Cassette	This circuit type is the <u>third</u> to be isolated during Stage II as the Isolation Plug is removed from the Test Block. Use to provide: <ul style="list-style-type: none"> <li>• Isolation of trip circuits</li> <li>• Remote 'Out of Service' indication</li> <li>• Isolation of inter-tripping circuits</li> <li>• Isolation of watchdog alarms</li> <li>• Isolation of VT circuits</li> <li>• Isolation of I/O circuits</li> </ul>	
3	Trip Cassette	This circuit type is the <u>second</u> to be isolated during Stage II as the Isolation Plug is removed from the Test Block. Use to provide: <ul style="list-style-type: none"> <li>• Isolation of trip circuits</li> <li>• Isolation of inter-tripping circuits</li> <li>• Isolation of watchdog alarms</li> </ul>	
8	CT cassette with shorting bar to the adjacent circuit below	Use for CT connections so that they will be automatically shorted <u>first</u> during Stage II as the Isolation Plug is removed. Shorting is made to the adjacent CT circuit below. After shorting, the CT circuit is isolated.	
9	Last CT cassette on a CT group	Use for CT connections so that they will be automatically shorted <u>first</u> during Stage II as the Isolation Plug is removed. Shorting is made to the adjacent CT circuit above. After shorting, the CT circuit is isolated.	



## Terminal Format

The product images, recommended wiring layout and application drawings are based on the 4M402-S and 4M422-S terminal format shown below. It should be noted that automatic CT shorting in the Test Block always takes place on the Live Side.

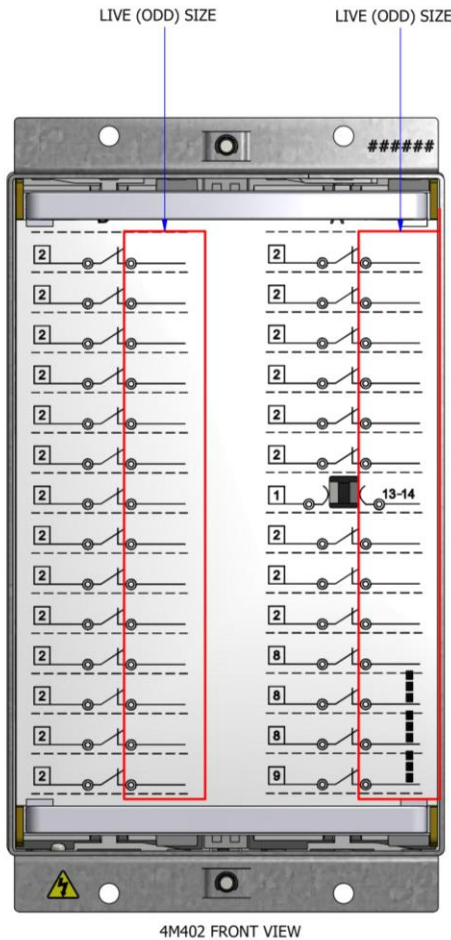

## CT Circuits

CT circuits must be specified with a cassette type: 8, 9, C, D, H, J, L, M, R or V

CT circuits must not be wired to cassette types 0, 1, 2 or 3 as this will result in open circuit CT's as the isolation plug is removed.

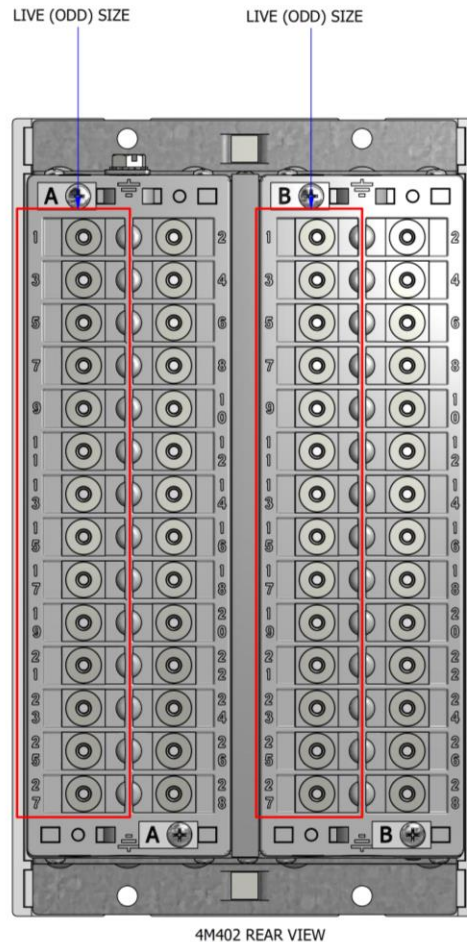

Figure 5: Position of Live Side terminals on 4M402-S Order Code versions

## Recommended Wiring Layout

It is recommended that the Test Block is wired with connections to the protective relay or scheme made to the EVEN numbered equipment side terminals. Connections to other equipment, e.g. CT's, VT's and DC supplies, should be made to the ODD numbered live side terminals on the Test Block. This ensures that when the Test Plug is inserted, the black sockets are connected to the isolated relay circuits and the yellow sockets are connected to the potentially live supplies as shown in figures 8 to 12.

## Test Plug Terminal Format

The product images, recommended wiring layout and application drawings are based on the 4M420-S terminal format shown below. It should be noted that automatic CT shorting in the Test Block always takes place on the Live Side.

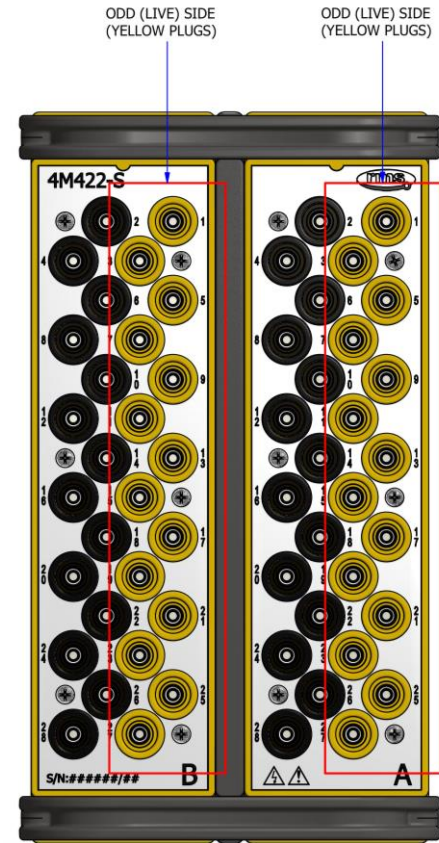

Figure 6: Position of Live Side terminals on 4M422-S Order Code versions

## Test Plug Terminal Format

The product images, recommended wiring layout and application drawings are based on the 4M420-S terminal format shown below. It should be noted that automatic CT shorting in the Test Block always takes place on the Live Side.



Figure 7: 4M422-S Test Plug  
Note 'finger safe' test sockets to accept 4mm shrouded test plugs

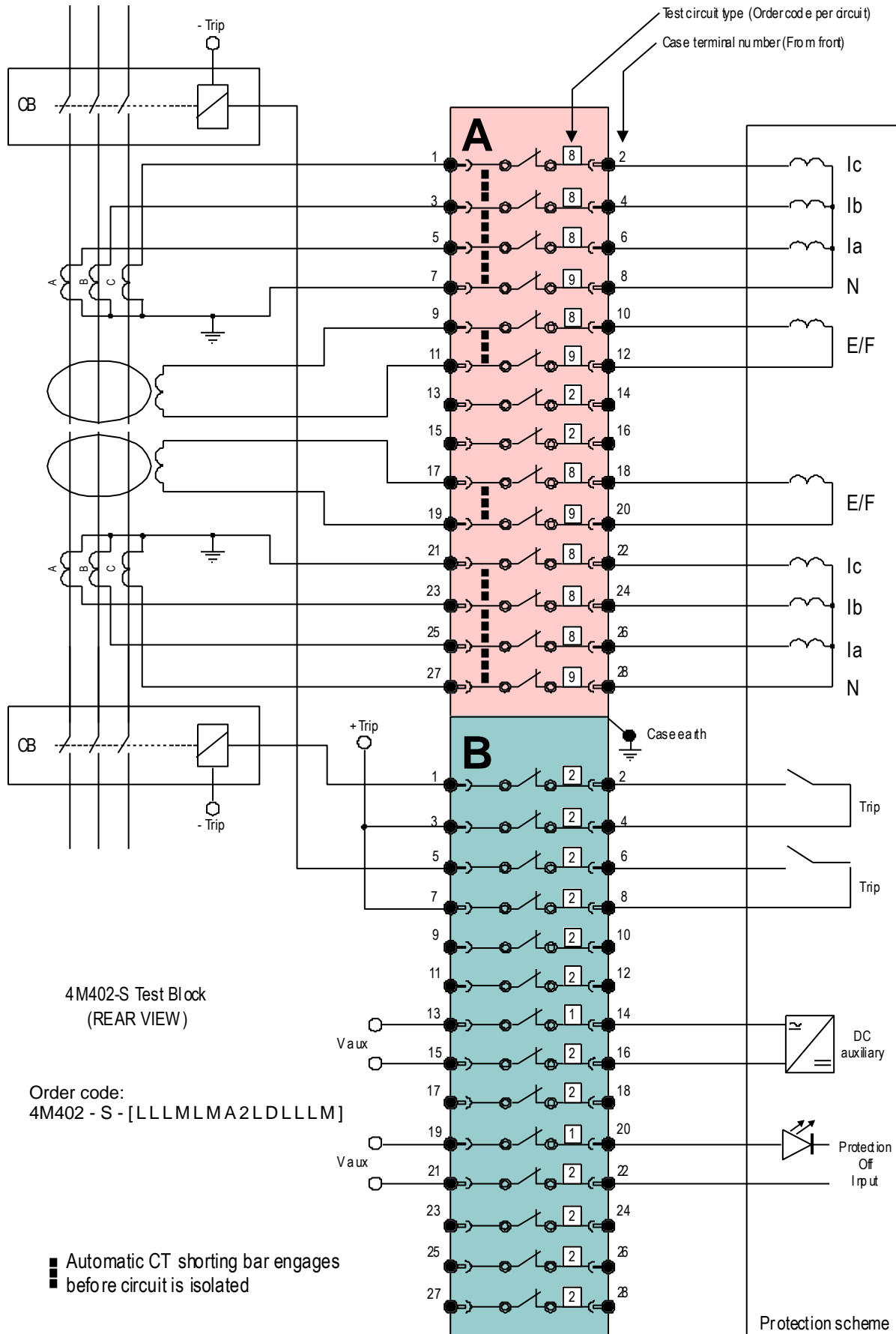

Figure 8: Application wiring example for differential protection of transformers with auto CT shorting (Rear terminal view)



## 4M402-06

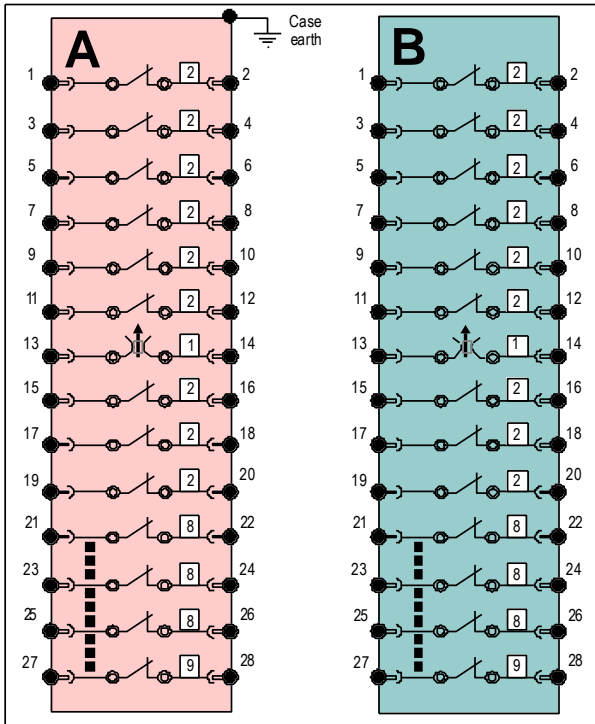

Figure 9: Viewed from rear terminal side  
 Full order code: 4M402-S- 2 2 2 2 2 2 2 2 2 2 2 8 8 9  
 Short code: 4M402-06

## 4M402-08

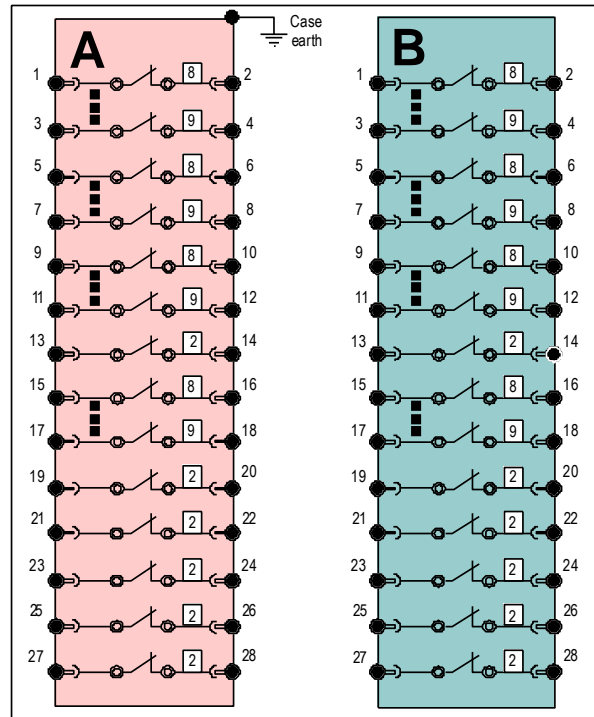

Figure 11: Viewed from rear terminal side  
 Full order code: 4M402-S- 8 9 8 9 8 9 2 8 9 2 2 2 2 2  
 Short code: 4M402-08

## 4M402-07

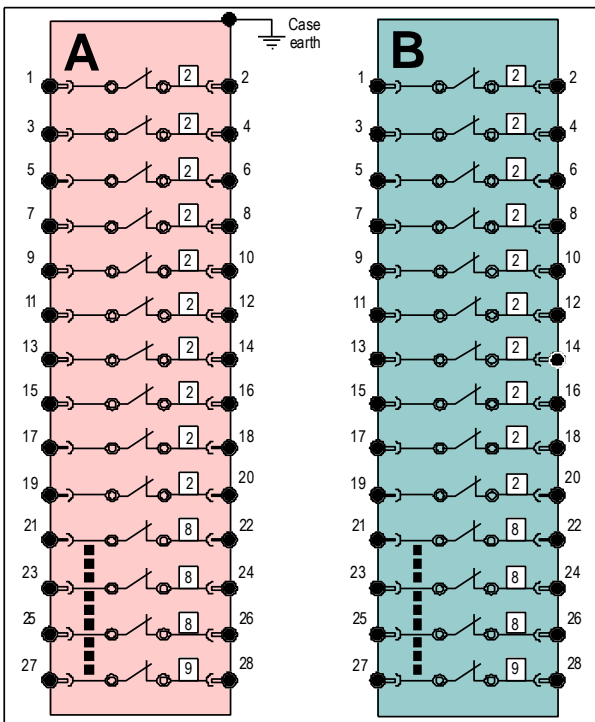

Figure 10: Viewed from rear terminal side  
 Full order code: 4M402-S- 2 2 2 2 2 2 2 2 2 2 2 8 8 8 9  
 Short code: 4M402-07

## 4M402-09

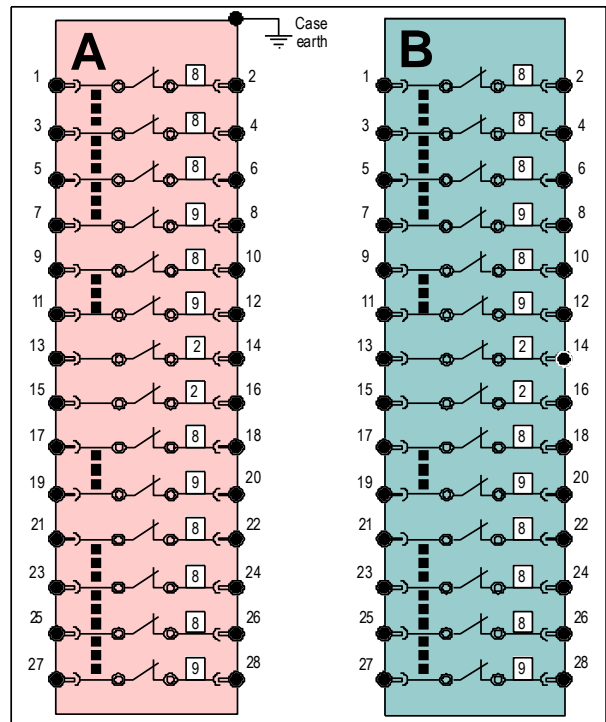

Figure 12: Viewed from rear terminal side  
 Full order code: 4M402-S- 8 8 8 9 8 9 2 2 8 9 8 8 8 9  
 Short code: 4M402-09

## Shrouded Test Leads

Two types of shrouded ‘finger safe’ test leads are available:

Part Number	Description
310-230-075-1	Two ended test lead - 75mm
310-230-180-1	Two ended test lead - 180mm

## Test Lead Plugs

### Single Plug

The single plug is the most compact and may be plugged into any test socket.

### Dual Plug

The dual or ‘piggy back’ plug is larger and should be plugged into the test sockets on the outside edge of the 4M422.

## Connecting Multiple Test Leads

Test leads may be linked in a daisy chain arrangement using the socket available at one end of each test lead.

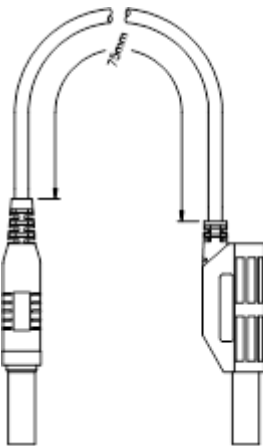

Figure 13: Two ended test lead - short  
 P/N 310-230-075-1  
 75mm wire length version depicted  
 Multi-strand conductor rated cross section 2.5 sq. mm

## 4M402 Test Block

28 Equipment side terminals (Even terminal numbers).

28 Live side terminals (Odd terminal numbers).

28 Live side to equipment side shorting links.

This arrangement provides for up to 28 independent circuits to be connected.

## 4M422 Multi-Finger Test Plug

56 test sockets suitable for 4mm shrouded ‘finger safe’ type or standard banana plugs.

Securing screws to retain the Test Plug during system testing operations.

## Current Ratings

CT circuits and terminals	20A	continuous
	400A	1s
Other circuits	10A	continuous
	200A	1s

## Rated Cross Section of Conductors

CT circuits and terminals	2.5 sq. mm
Other circuits	0.75 sq. mm

## Case Type

4M56-S	Size 4 continuous 56 terminals
Mounting	Flush 4U high rack mount

## Individual Transport Packaging

1x 4M402 Test Block in a size 4 packing box

Size: 360 x 250 x 100mm

Weight: 2 Kg

## Insulation – 4M402 - In Service

Standard	IEC 61010-2-030
Type	Level
Between any contact pair & either adjacent contact pair.	3.3kV ac rms for 1 minute
Between all case terminals & the case earth	5.0kV ac rms for 1 minute
Between any alternate contact pair, provided that the intermediate pair is not used.	5.0kV ac rms for 1 minute

## Insulation – 4M422

Standard	IEC 61010-2-030
Type	Level
Between any contact.	3.3kV ac rms for 1minute
Between any alternate contact pair, provided that the intermediate pair is not used.	5.0kV ac rms for 1 minute

## Insulation – 4M402 with 4M422 Fitted

Standard	IEC 61010-2-030
Type	Level
Between incoming & outgoing contacts.	3.3kV ac rms for 1minute
Between all case terminals & the case earth	5.0kV ac rms for 1 minute

## Voltage Rating

Standard	IEC 60255-27
All circuits and terminals	600V AC continuous 320V DC continuous
System auxiliary voltage:	40V DC minimum

## Performance Standard

Low-voltage switchgear and control gear

Part 7.1: Ancillary equipment – Terminal blocks for copper conductors

Standard	IEC 60947-7-1
----------	---------------

## Temperature

Standard	IEC 60068-2-1/2
Operating Range	-10 to +55 degrees Celsius
Storage Range	-25 to +70 degrees Celsius

## Humidity

Standard	IEC 60068-2-78
Operating Range	40 degrees Celsius and 93% RH non condensing

## IP Rating

Standard	IEC 60529
Installed	IP5x

## Vibration - Sinusoidal

Standard	IEC 60255-21-1 Class I	
Vibration Response	0.5gn	≤ 5%
Vibration Endurance	1.0gn	≤ 5%

## Shock and Bump

Standard	IEC 60255-21-2 Class I	
Shock Response	5gn, 11ms	≤ 5%
Shock Withstand	15gn, 11ms	≤ 5%
Bump Test	10gn, 16ms	≤ 5%

## Seismic

Standard	IEC 60255-21-3 Class I	
Seismic Response	1gn	≤ 5%

## Mechanical Classification

Durability	> 10 <sup>5</sup> operations at no load
------------	---

## Front View

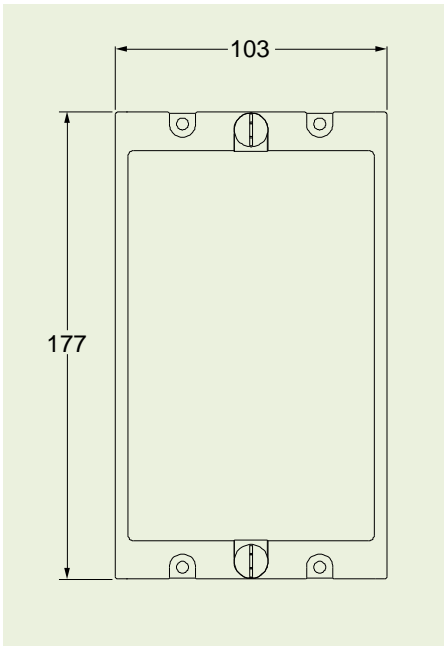

## Rear View

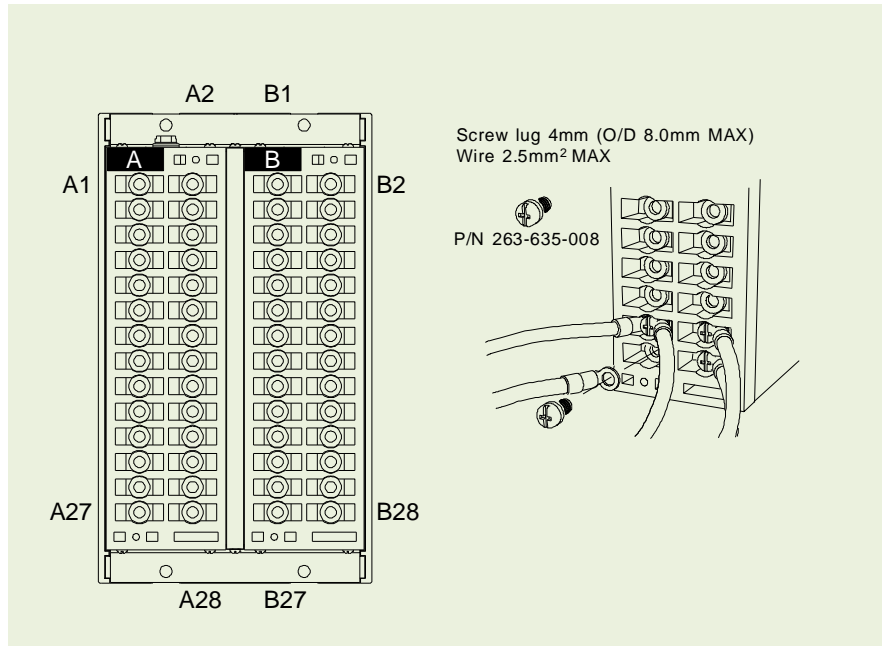

## Panel Cut-out

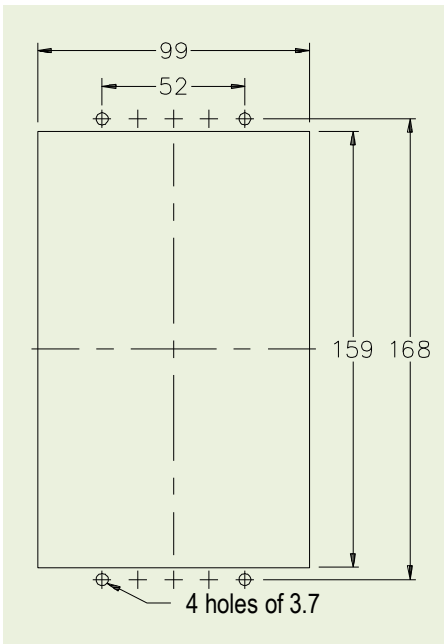

## Side View

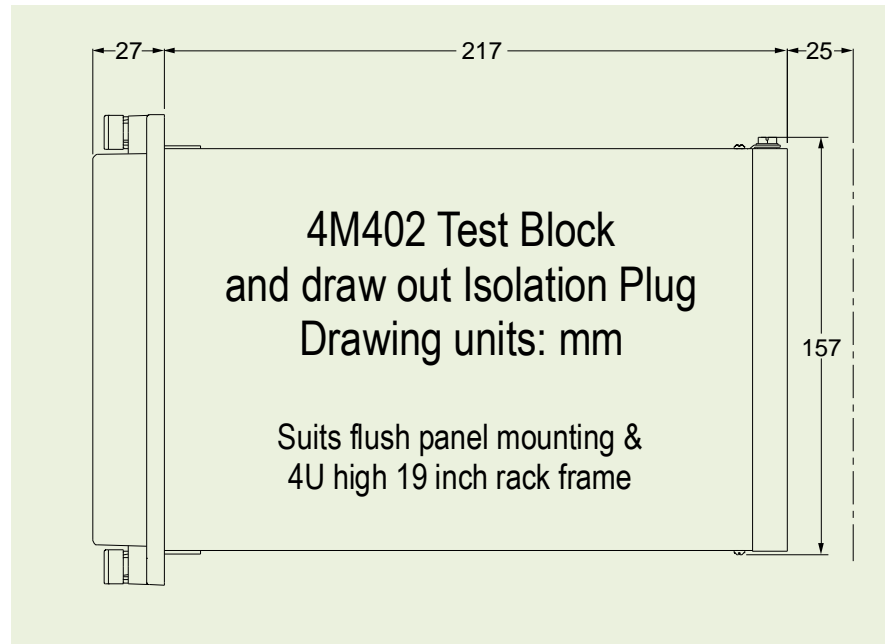

Figure 14: 4M402-S Case details

## Standard Test Block Configuration Codes

4M402 -	<input type="checkbox"/>	[ Equivalent test circuit pair order codes ]
	<b>06</b>	[ 2 2 2 2 2 2 1 2 2 2 8 8 8 9 ] Figure 9
	<b>07</b>	[ 2 2 2 2 2 2 2 2 2 2 8 8 8 9 ] Figure 10
	<b>08</b>	[ 8 9 8 9 8 9 2 8 9 2 2 2 2 2 ] Figure 11
	<b>09</b>	[ 8 8 8 9 8 9 2 2 8 9 8 8 8 9 ] Figure 12

## Test Plug

The 4M422-S is the default Test Plug version and is suitable for application with all 4M402-S Test Blocks.

4M422 -	<input type="checkbox"/>	
	<b>S</b>	Live Side YELLOW terminals on RIGHT

## Test Circuit Groups

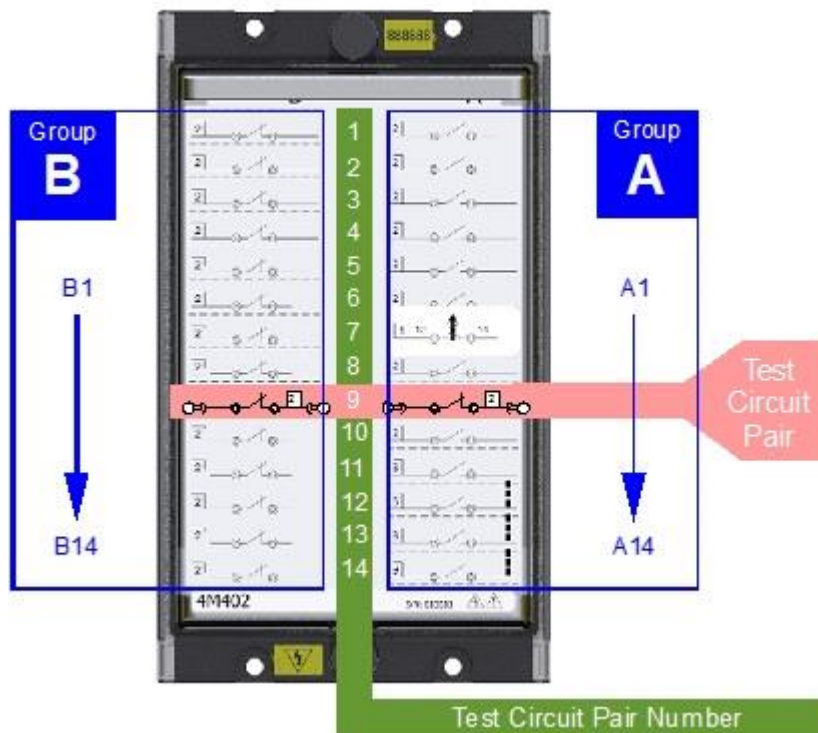
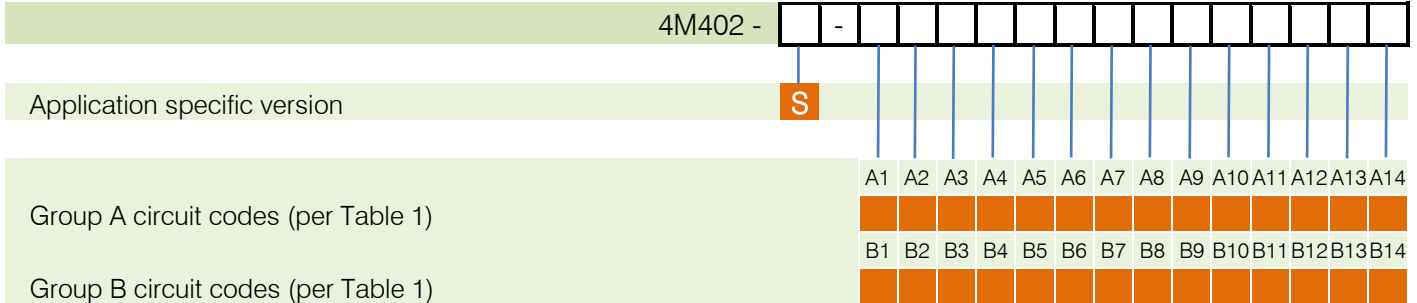

Figure 15: 4M402-S Test circuit groups



## Test Block Configuration



For each test circuit pair, 1 through to 14, utilize the test circuit pair look up table to determine the test circuit pair order code. For example, one of the pairs utilizes test circuit type 2 on Group A and test circuit type 1 on Group B.

This yields a test circuit pair order A as per table 2:

## Test Circuit Group Order Codes

	A	0	1	2	3	8	9	
B		0	-	-	-	-	-	
	1	-	1	A	B	C	D	
	2	-	K	2	E	L	M	
	3	-	F	G	3	H	J	
	8	-	N	P	8	R		Not allowed in Position 14
	9	-	S	T	9	V		Not allowed in Position 1
					Not allowed in Position 14	Not allowed in Position 1		

Table 2

Type	Description
0	Blank circuit
1	Test Block Cover
2	General Purpose Cassette
3	Trip Cassette
8	CT cassette with shorting bar to the adjacent circuit below
9	Last CT cassette CT group

- Notes:
1. Type 1 cassettes cannot be specified in adjacent positions.
  2. A maximum of four (4) CT cassettes may be specified in a single group.
  3. CT circuits must be specified with a cassette type 8 or 9 in Group A or B.
  4. Refer to figure 2 for timing diagram of CT shorting and circuit isolation.

---

**RMS Mors Smitt**  
19 Southern Court  
Keysborough, VIC 3173, Australia  
Tel: +61 (0)3 8544 1200  
sales.rms@wabtec.com



**Wabtec Netherlands B.V.**  
Darwinstraat 10  
6718 XR Ede, Netherlands  
Tel: +31 (0)88 600 4500  
wnl\_salessupport@wabtec.com



Visit [www.morssmitt.com/rms](http://www.morssmitt.com/rms) for the latest product information.  
Due to RMS continuous product improvement policy this information is subject to change without notice.